

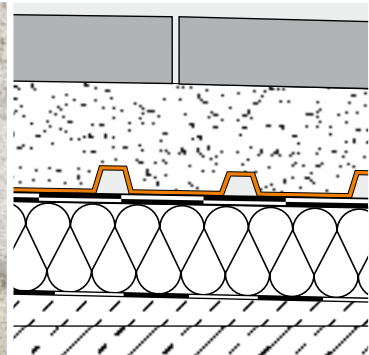

Roof Terraces

Structural assemblies

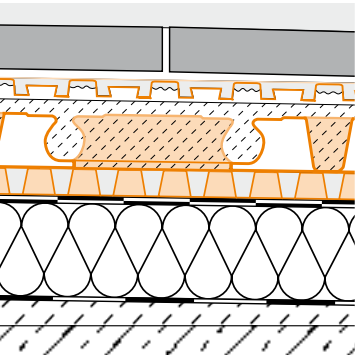

PROFILE OF INNOVATION



Practical solutions from an expert source

Schlüter-Systems has been a brand name for intelligent structural assemblies on balconies and terraces since 1983. That year, Werner Schlüter invented the Schlüter-TROBA mat, the first drainage mat for the area drainage of balconies and terraces.

Since then, Schlüter-Systems has developed a complete product range of integrated components for any type of structural assembly. Schlüter-Systems offers designers and contractors everything for the complete assembly of balconies, ground level terraces and roof terraces from a single source, ranging from area drainage to bonded waterproofing assemblies, uncoupling, edge profiles and gutters.

As numerous building projects have documented, balconies and terraces constructed properly with Schlüter-Systems products are permanently free of damage, even under extreme weather conditions.

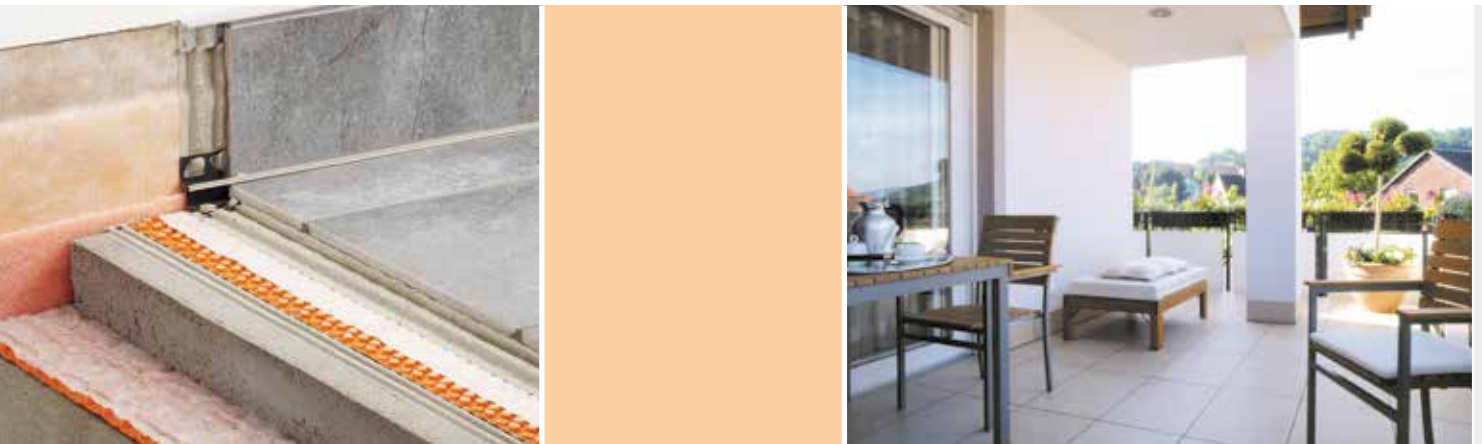

The installation recommendations and construction drawings of this brochure were developed on the basis of the relevant DIN requirements, guidelines and technical information sheets and in accordance with the practical and theoretical knowledge of the authors. The product data sheets of the Schlüter products must be observed. However, designers and contractors are solely responsible for the proper application of the products in individual cases.

The ZDB information sheet “Tiled assemblies in outside areas” states: “Natural stone and concrete pavers may vary in colour due to differences in the drying process.” This occurrence cannot be completely ruled out for the structural assemblies described in this booklet. We recommend pointing this out to the homeowner or developer when selecting the covering materials.

Information regarding the arrangement of joints and slopes as well as other construction details represents recommendations of Schlüter-Systems KG and must be adapted to local requirements as applicable.



Contents

C.3 Thin covering assemblies over waterproofing layers according to DIN 18531	
Bonded drainage and uncoupling over screeds installed on a drainage membrane _____	4
Edge details _____	5
Wall transition, threshold _____	6
Floor drain _____	7
C.4 Thin covering assemblies over waterproofing layers in mortar beds according to DIN 18531	
Mortar bed installation on area drainage _____	8
Edge details _____	9
Wall transition, threshold _____	10
Floor drain _____	10
C.5 Covering assemblies over waterproofing layers according to DIN 18531	
Waterproofing, drainage, load distribution layer, bonded drainage and uncoupling _____	11
Edge details _____	12
Wall transition, threshold _____	13
Floor drain _____	14
C.6 Loose installation over Schlüter®-TROBA-PLUS 8G	
Attached with thin bed mortar points _____	15
Edge details _____	16
Wall transition _____	17
Threshold _____	17
C.7 Covering assemblies over mortar stilts	
Installation with mortar rings _____	18
Edge details _____	19
Wall transition _____	20
Threshold _____	20
C.8 Coverings installed over gravel/crushed stone beds	
Loose installation _____	21
Edge details _____	22
Wall transition _____	24
Threshold _____	24
C.9 Other details _____	25
Edge drainage _____	25
Drainage/thresholds _____	26
Barrier free assemblies _____	27
Movement joints _____	28
Skirtings _____	29
Profile cross sections _____	30

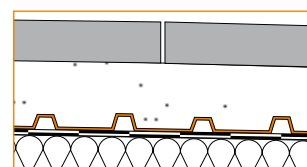
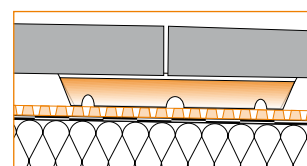
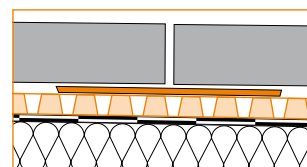
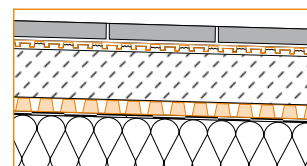
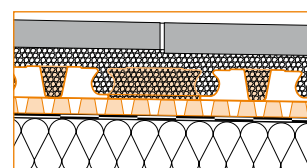
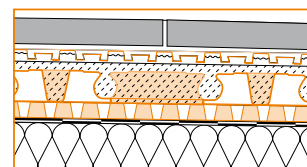

i

Schlüter-TROBA-LEVEL, the new mortar free paver support system in a simple modular design. schlueter-systems.com



C.3 Thin covering assemblies over waterproofing layers according to DIN 18531

Schlüter®-DITRA-DRAIN as a bonded drainage and uncoupling membrane over Schlüter®-BEKOTEC-DRAIN screed on the Schlüter®-TROBA-PLUS drainage mat

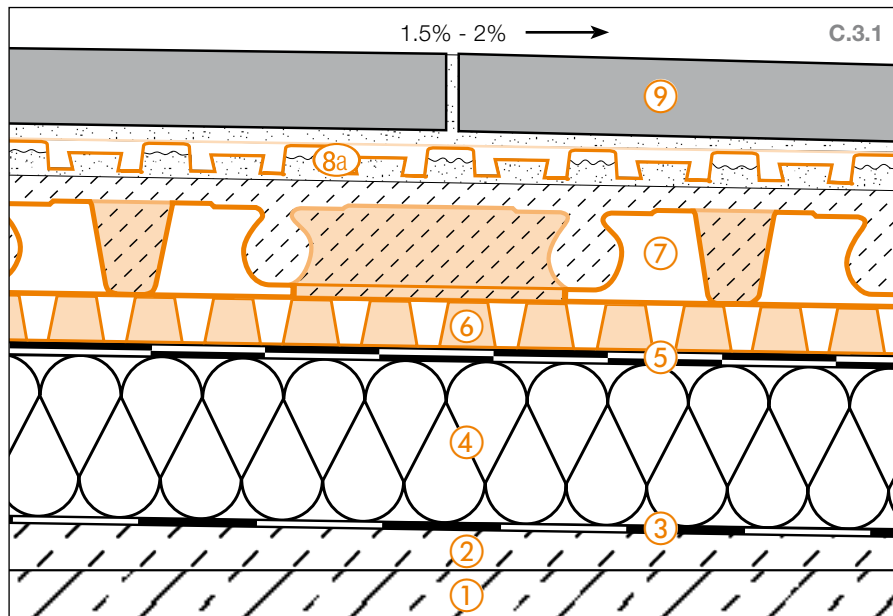

- ① **Concrete slab.**
- ② **Sloped screed**
The construction has to be sufficiently sloped (1.5% - 2%) to allow for proper drainage. Please contact us if you have alternative substrate assemblies.
- ③ **Vapour barrier according to DIN 18531.**
- ④ **Insulation**
Thickness according to construction requirements.
- ⑤ **Waterproofing assembly according to DIN 18531.**
- ⑥ **Schlüter®-TROBA-PLUS**
Passive capillary membrane for the effective drainage of seepage and ventilation. It is important to ensure a drainage channel.
- ⑦ **Schlüter®-BEKOTEC-DRAIN**
Thin load distribution layer as a system for damage free and functionally safe floating screeds (cement screed CT-C25-F4 or pervious mortar).
- ⑧ **Schlüter®-DITRA-DRAIN 4**
Polyethylene drainage mat installed with the thin set method, for drainage, ventilation and uncoupling.
- ⑧b **Schlüter®-DITRA-DRAIN 8**
Special bonded drainage membrane for large areas and staircase assemblies.
- ⑨ **Ceramic tiles or natural stone pavers**
Installed (including large format) with a waterproof and weather resistant dry set tile adhesive.

The sloped support structure is protected against permeating water with a waterproofing assembly that meets the requirements of DIN 18531. Schlüter-TROBA-PLUS is installed as a drainage membrane between the waterproofing layer and the load distribution layer (screed) to drain away seepage. This load distribution layer is installed as a thin layer, using the damage free and non

buckling Schlüter-BEKOTEC-DRAIN system. The passive capillary bonded drainage and bonded uncoupling membrane Schlüter-DITRA-DRAIN is installed in the thin bed mortar between the screed and the tile covering. This results in the broad ventilation of the top covering, which in turn promotes the quick and even drying/curing of the thin bed tile adhesive.



Edge detail 1

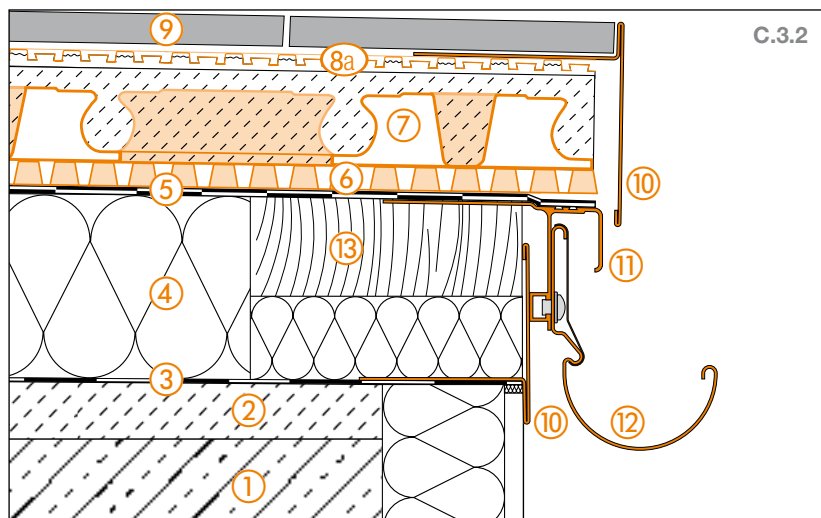

- ① Concrete slab.
- ② Sloped screed (1.5% - 2%).
- ③ Vapour barrier according to DIN 18531.
- ④ Insulation.
- ⑤ Waterproofing assembly according to DIN 18531.
- ⑥ Schlüter®-TROBA-PLUS.
- ⑦ Schlüter®-BEKOTEC-DRAIN.
- ⑧a Schlüter®-DITRA-DRAIN 4.
- ⑧b Schlüter®-DITRA-DRAIN 8.
- ⑨ Ceramic tiles or natural stone pavers.
- ⑩ Schlüter®-BARA-RT
It is important to ensure a drainage channel.
- ⑪ Schlüter®-BARA-RTK.
- ⑫ Schlüter®-BARIN.
- ⑬ Edge beam.

Edge detail 2

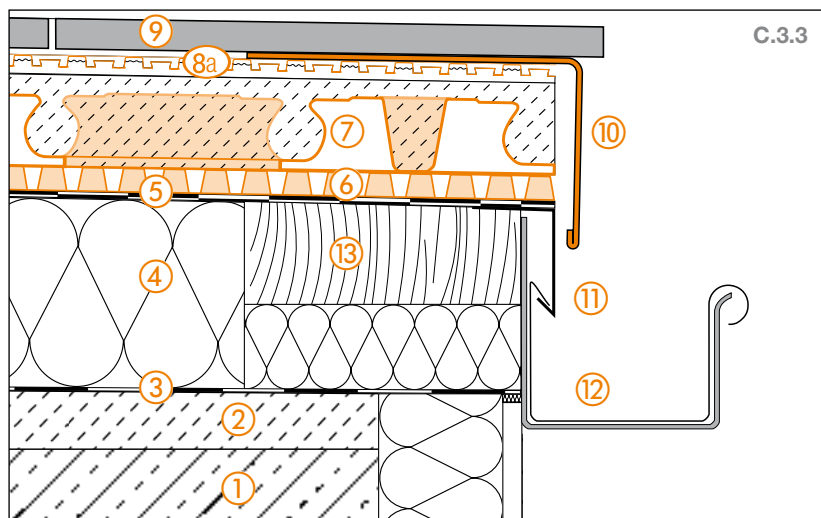

- ① Concrete slab.
- ② Sloped screed (1.5% - 2%).
- ③ Vapour barrier according to DIN 18531.
- ④ Insulation.
- ⑤ Waterproofing assembly according to DIN 18531.
- ⑥ Schlüter®-TROBA-PLUS.
- ⑦ Schlüter®-BEKOTEC-DRAIN.
- ⑧a Schlüter®-DITRA-DRAIN 4.
- ⑧b Schlüter®-DITRA-DRAIN 8.
- ⑨ Ceramic tiles or natural stone pavers.
- ⑩ Schlüter®-BARA-RW
It is important to ensure a drainage channel.
- ⑪ Eave flashing.
- ⑫ DIN compliant gutter.
- ⑬ Edge beam.





Wall transition

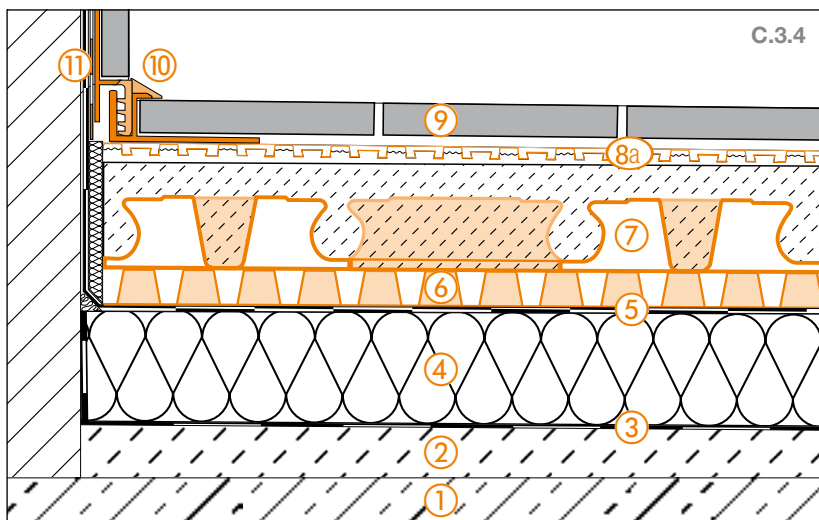

- ① Concrete slab.
- ② Sloped screed (1.5% - 2%).
- ③ Vapour barrier according to DIN 18531.
- ④ Insulation.
- ⑤ Waterproofing assembly according to DIN 18531.
- ⑥ Schlüter®-TROBA-PLUS.
- ⑦ Schlüter®-BEKOTEC-DRAIN.
- ⑧a Schlüter®-DITRA-DRAIN 4.
- ⑧b Schlüter®-DITRA-DRAIN 8.
- ⑨ Ceramic tiles or natural stone pavers.
- ⑩ Schlüter®-DILEX-EK or Schlüter®-DILEX-RF.
- ⑪ Schlüter®-KERDI.

Threshold

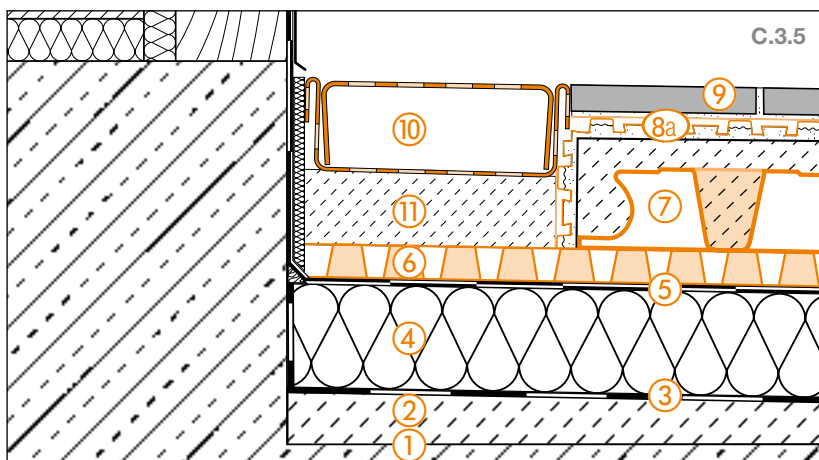

- ① Concrete slab.
- ② Sloped screed (1.5% - 2%).
- ③ Vapour barrier according to DIN 18531.
- ④ Insulation.
- ⑤ Waterproofing assembly according to DIN 18531.
- ⑥ Schlüter®-TROBA-PLUS.
- ⑦ Schlüter®-BEKOTEC-DRAIN.
- ⑧a Schlüter®-DITRA-DRAIN 4.
- ⑧b Schlüter®-DITRA-DRAIN 8.
- ⑨ Ceramic tiles or natural stone pavers.
- ⑩ Schlüter®-TROBA-LINE-TL
Keep drainage openings unobstructed.
- ⑪ Mortar bed

i

For more information on thresholds,
please see pages 26 and 27.



Floor drain

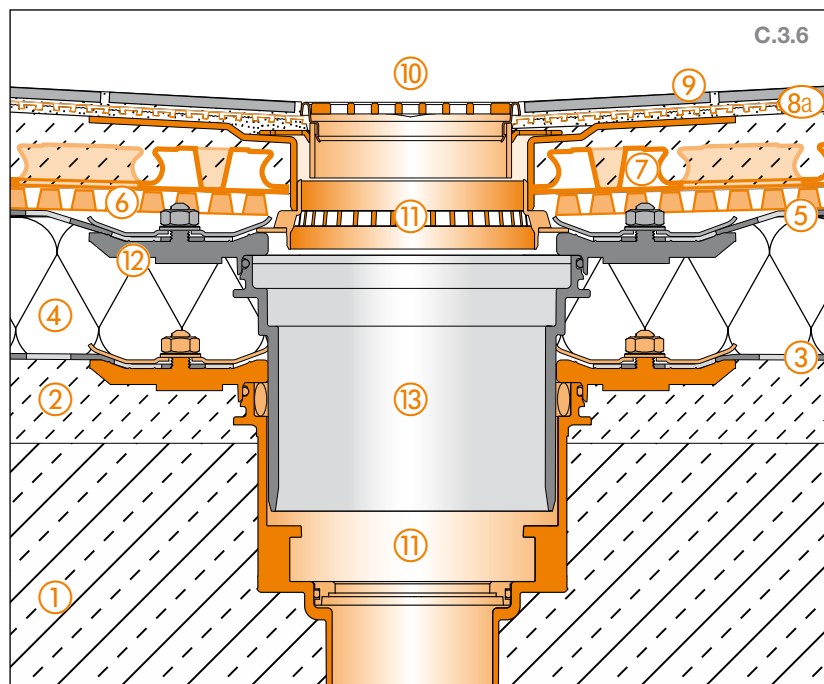

- ① Concrete slab.
- ② Sloped screed (1.5% - 2%).
- ③ Vapour barrier according to DIN 18531.
- ④ Insulation.
- ⑤ Waterproofing assembly according to DIN 18531.
- ⑥ Schlüter®-TROBA-PLUS.
- ⑦ Schlüter®-BEKOTEC-DRAIN.
- ⑧a Schlüter®-DITRA-DRAIN 4.
- ⑧b Schlüter®-DITRA-DRAIN 8.
- ⑨ Ceramic tiles or natural stone pavers.
- ⑩ Schlüter®-KERDI-DRAIN
Grate/frame set KD R10.
Keep drainage openings unobstructed!
- ⑪ Schlüter®-KERDI-DRAIN
Floor drain set KD BV 50 MSBB.
- ⑫ Waterproofing connection (upon request).
- ⑬ Extension for floor drains (upon request).





C.4 Thin covering assemblies over waterproofing layers in mortar beds according to DIN 18531

Schlüter®-BEKOTEC-DRAIN and mortar bed installation on area drainage with Schlüter®-TROBA-PLUS 8G

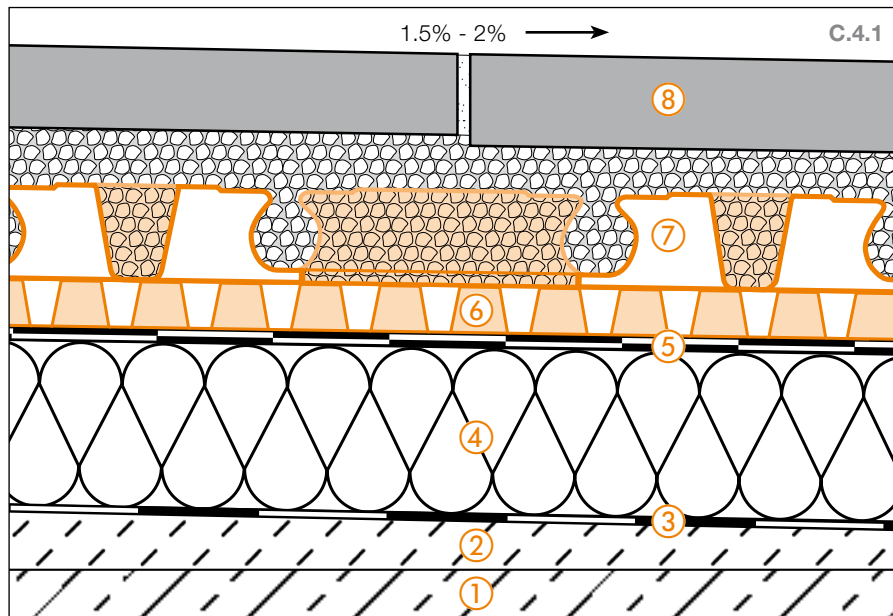

The sloped support structure is protected against permeating water with a waterproofing assembly that meets the requirements of DIN 18531. Schlüter-TROBA-PLUS 8G is installed as a drainage membrane between the waterproofing layer and the load distribution layer (screed) to drain

away seepage. This load distribution layer of sand and cement screed or pervious mortar is installed as a thin layer, using the Schlüter-BEKOTEC-DRAIN system. The natural stone pavers are embedded in the fresh mortar.



- ① **Concrete slab.**
- ② **Sloped screed**
The construction has to be sufficiently sloped (1.5% - 2%) to allow for proper drainage. Please contact us if you have alternative substrate assemblies.
- ③ **Vapour barrier according to DIN 18531.**
- ④ **Insulation**
Thickness according to construction requirements.
- ⑤ **Waterproofing assembly according to DIN 18531.**
- ⑥ **Schlüter®-TROBA-PLUS 8G**
Passive capillary area drainage for the effective drainage of seepage and ventilation. It is important to ensure a drainage channel.
- ⑦ **Schlüter®-BEKOTEC-DRAIN**
Thin mortar layer, installed as a system for damage free and functionally secure tile and natural stone coverings, directly applied in the fresh mortar bed with a contact layer of cement mortar or pervious mortar, with high water permeability.
- ⑧ **Ceramic tiles or natural stone pavers**
Direct installation over the green load distribution layer.

Edge detail 1

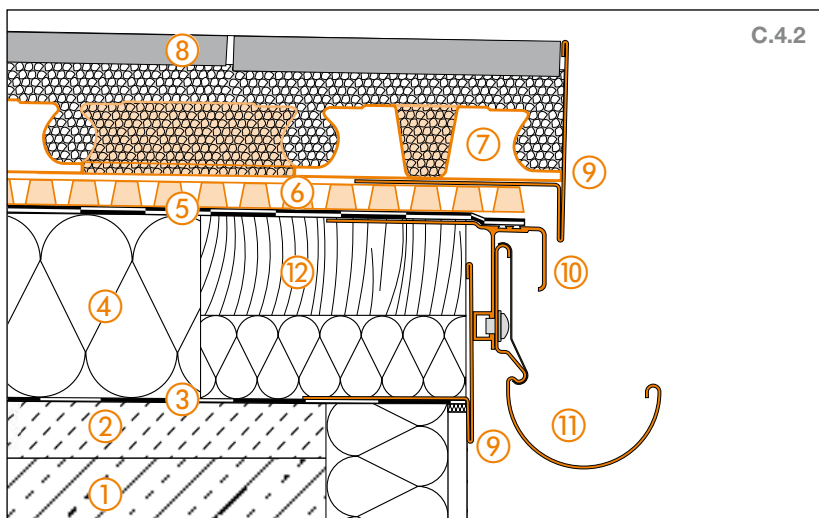

- ① Concrete slab.
- ② Sloped screed (1.5% - 2%).
- ③ Vapour barrier according to DIN 18531.
- ④ Insulation.
- ⑤ Waterproofing assembly according to DIN 18531.
- ⑥ Schlüter®-TROBA-PLUS 8G.
- ⑦ Schlüter®-BEKOTEC-DRAIN.
- ⑧ Ceramic tiles or natural stone pavers.
- ⑨ Schlüter®-BARA-RT
It is important to ensure a drainage channel.
- ⑩ Schlüter®-BARA-RTK.
- ⑪ Schlüter®-BARIN.
- ⑫ Edge beam.

Edge detail 2

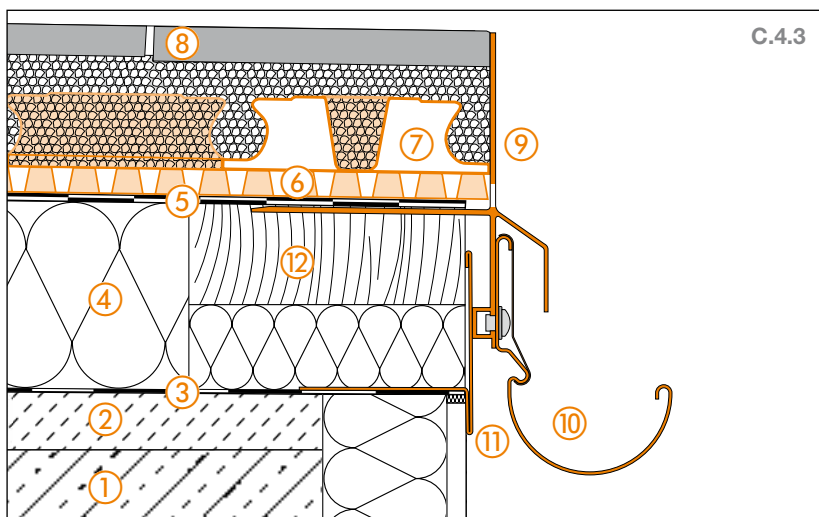

- ① Concrete slab.
- ② Sloped screed (1.5% - 2%).
- ③ Vapour barrier according to DIN 18531.
- ④ Insulation.
- ⑤ Waterproofing assembly according to DIN 18531.
- ⑥ Schlüter®-TROBA-PLUS 8G.
- ⑦ Schlüter®-BEKOTEC-DRAIN.
- ⑧ Ceramic tiles or natural stone pavers.
- ⑨ Schlüter®-BARA-RKLT
Keep drainage openings unobstructed.
- ⑩ Schlüter®-BARIN.
- ⑪ Schlüter®-BARA-RT.
- ⑫ Edge beam.

Edge detail 3

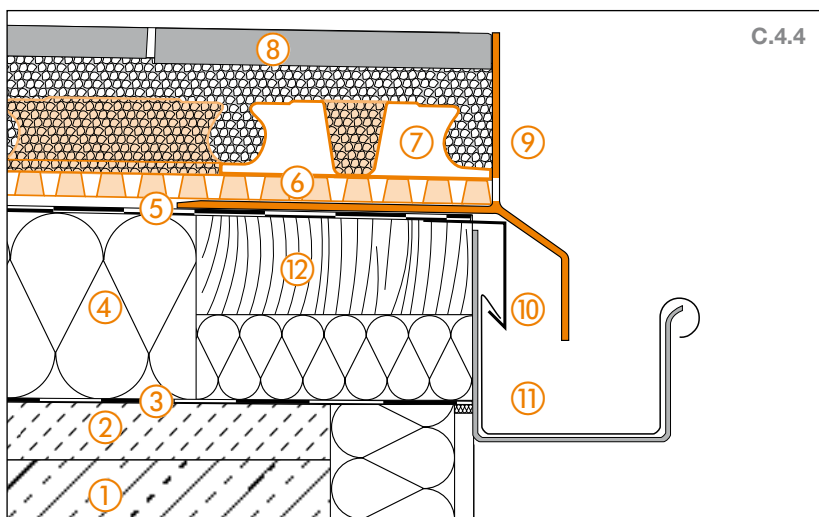

- ① Concrete slab.
- ② Sloped screed (1.5% - 2%).
- ③ Vapour barrier according to DIN 18531.
- ④ Insulation.
- ⑤ Waterproofing assembly according to DIN 18531.
- ⑥ Schlüter®-TROBA-PLUS 8G.
- ⑦ Schlüter®-BEKOTEC-DRAIN.
- ⑧ Ceramic tiles or natural stone pavers.
- ⑨ Schlüter®-BARA-RKL
Keep drainage openings unobstructed.
- ⑩ Eave flashing.
- ⑪ DIN compliant gutter.
- ⑫ Edge beam.





Wall transition

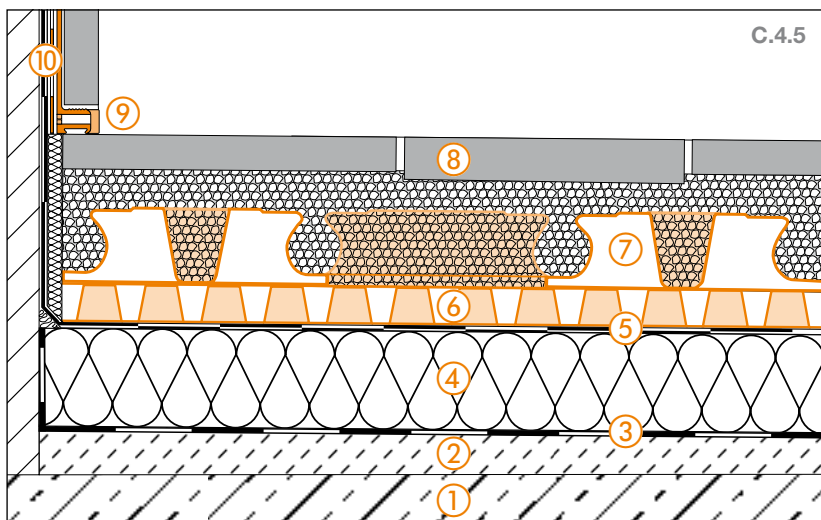

- ① Concrete slab.
- ② Sloped screed (1.5% - 2%).
- ③ Vapour barrier according to DIN 18531.
- ④ Insulation.
- ⑤ Waterproofing assembly according to DIN 18531.
- ⑥ Schlüter®-TROBA-PLUS 8G.
- ⑦ Schlüter®-BEKOTEC-DRAIN.
- ⑧ Ceramic tiles or natural stone pavers.
- ⑨ Schlüter®-DILEX-BWA.
- ⑩ Schlüter®-KERDI-KEBA.

Threshold

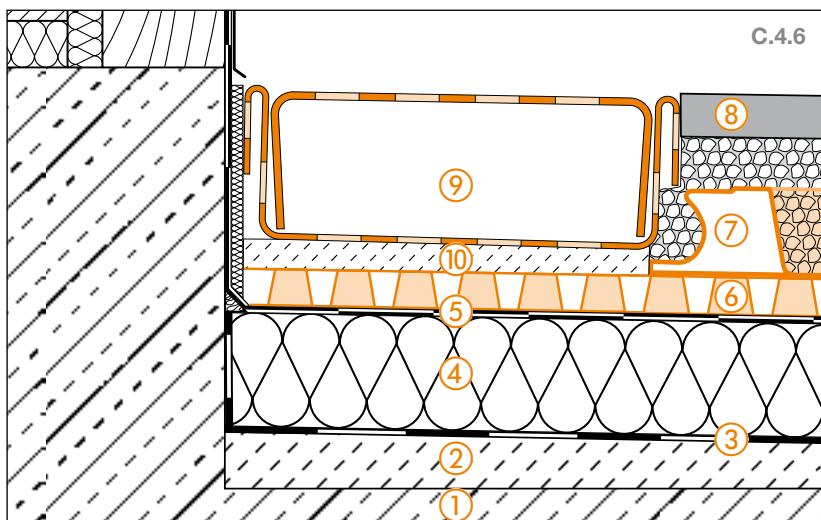

- ① Concrete slab.
- ② Sloped screed (1.5% - 2%).
- ③ Vapour barrier according to DIN 18531.
- ④ Insulation.
- ⑤ Waterproofing assembly according to DIN 18531.
- ⑥ Schlüter®-TROBA-PLUS 8G.
- ⑦ Schlüter®-BEKOTEC-DRAIN.
- ⑧ Ceramic tiles or natural stone pavers.
- ⑨ Schlüter®-TROBA-LINE-TL.
- ⑩ Mortar spot bedding.

i

For more information on thresholds, please see pages 26 and 27.

Floor drain

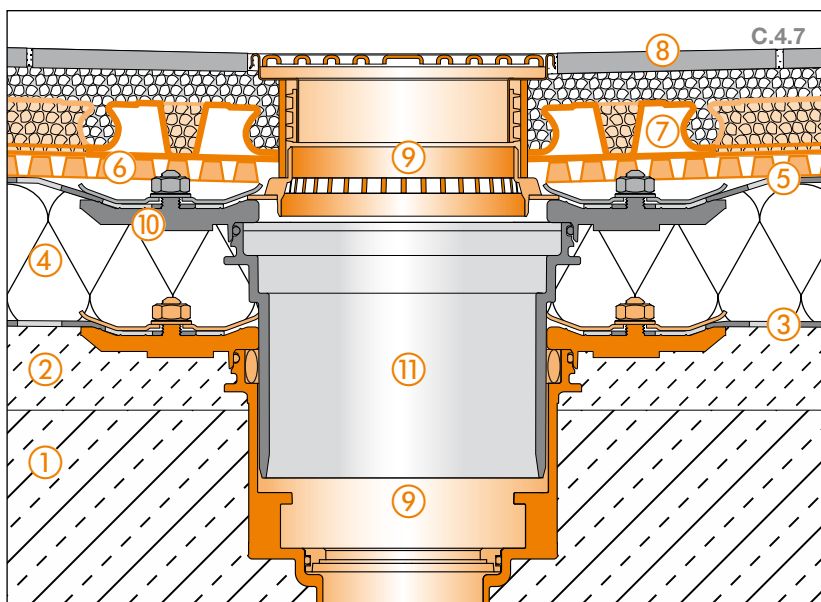

- ① Concrete slab.
- ② Sloped screed (1.5% - 2%).
- ③ Vapour barrier according to DIN 18531.
- ④ Insulation.
- ⑤ Waterproofing assembly according to DIN 18531.
- ⑥ Schlüter®-TROBA-PLUS 8G.
- ⑦ Schlüter®-BEKOTEC-DRAIN.
- ⑧ Ceramic tiles or natural stone pavers.
- ⑨ Schlüter®-KERDI-DRAIN Complete set KD BV 50 ASLVB.
- ⑩ Schlüter®-KERDI-KEBA.
- ⑪ Extension for floor drains (upon request).



C.5 Covering assemblies over waterproofing layers according to DIN 18531

Waterproofing, drainage, load distribution layer, bonded drainage and uncoupling

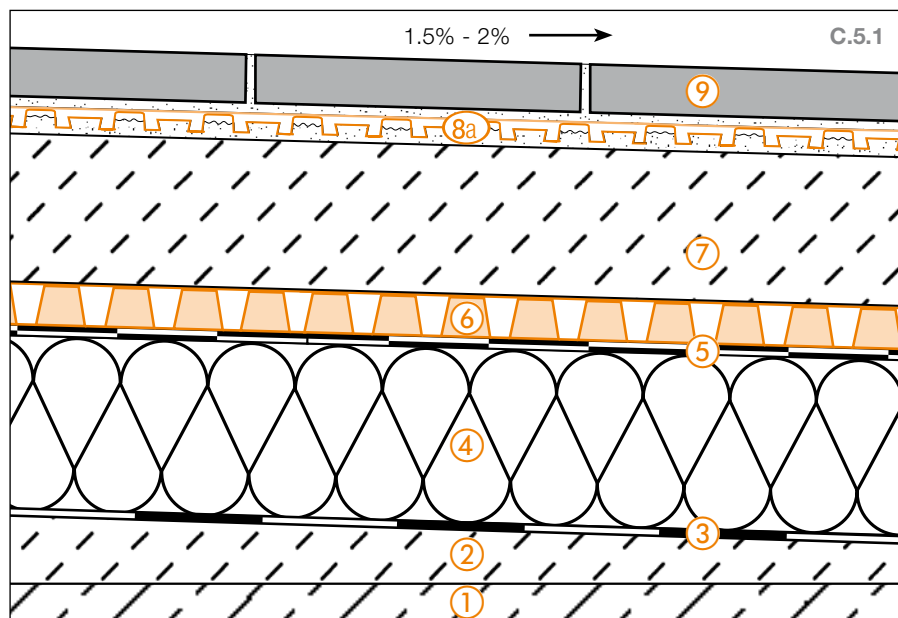

- ① **Concrete slab.**
- ② **Sloped screed**
The construction has to be sufficiently sloped (1.5% - 2%) to allow for proper drainage. Please contact us if you have alternative substrate assemblies.
- ③ **Vapour barrier according to DIN 18531.**
- ④ **Insulation**
Thickness according to construction requirements.
- ⑤ **Waterproofing assembly according to DIN 18531.**
- ⑥ **Schlüter®-TROBA-PLUS**
Passive capillary area drainage for the effective drainage of seepage and ventilation. It is important to ensure a drainage channel.
- ⑦ **Load distribution layer/screed**
Cement screed according to DIN 18560-2 or pervious mortar.
- ⑧a **Schlüter®-DITRA-DRAIN 4**
Polyethylene drainage mat installed with the thin set method, for drainage, ventilation and uncoupling.
- ⑧b **Schlüter®-DITRA-DRAIN 8**
Special bonded drainage membrane for large areas and staircase assemblies.
- ⑨ **Ceramic tiles or natural stone pavers**
Installed (including large format) with a waterproof and weather resistant dry set adhesive.

The sloped support structure is protected against permeating water with a waterproofing assembly that meets the requirements of DIN 18531. Schlüter-TROBA-PLUS is installed as a drainage membrane between the waterproofing layer and the load distribution layer (screed) to drain away seepage. The passive capillary bonded drainage

and uncoupling membrane Schlüter-DITRA-DRAIN is installed in the thin bed tile adhesive between the screed and the tile covering. This results in the broad ventilation of the top covering, which in turn promotes the quick and even drying/curing of the thin bed mortar.





Edge detail 1

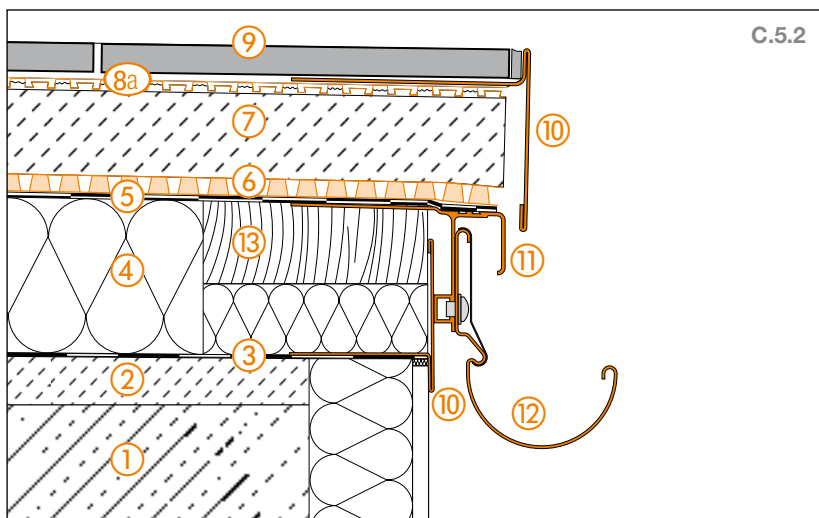

- ① Concrete slab.
- ② Sloped screed (1.5% - 2%).
- ③ Vapour barrier according to DIN 18531.
- ④ Insulation.
- ⑤ Waterproofing assembly according to DIN 18531.
- ⑥ Schlüter®-TROBA-PLUS.
- ⑦ Load distribution layer/screed.
- ⑧a Schlüter®-DITRA-DRAIN 4.
- ⑧b Schlüter®-DITRA-DRAIN 8.
- ⑨ Ceramic tiles or natural stone pavers.
- ⑩ Schlüter®-BARA-RT
It is important to ensure a drainage channel.
- ⑪ Schlüter®-BARA-RTK.
- ⑫ Schlüter®-BARIN.
- ⑬ Edge beam.

Edge detail 2

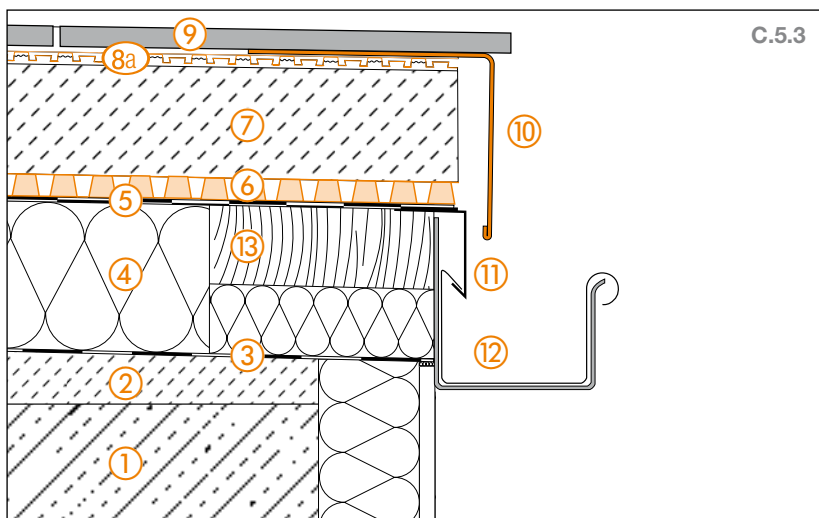

- ① Concrete slab.
- ② Sloped screed (1.5% - 2%).
- ③ Vapour barrier according to DIN 18531.
- ④ Insulation.
- ⑤ Waterproofing assembly according to DIN 18531.
- ⑥ Schlüter®-TROBA-PLUS.
- ⑦ Load distribution layer/screed.
- ⑧a Schlüter®-DITRA-DRAIN 4.
- ⑧b Schlüter®-DITRA-DRAIN 8.
- ⑨ Ceramic tiles or natural stone pavers.
- ⑩ Schlüter®-BARA-RW
It is important to ensure a drainage channel.
- ⑪ Eave flashing.
- ⑫ DIN compliant gutter.
- ⑬ Edge beam.

Wall transition

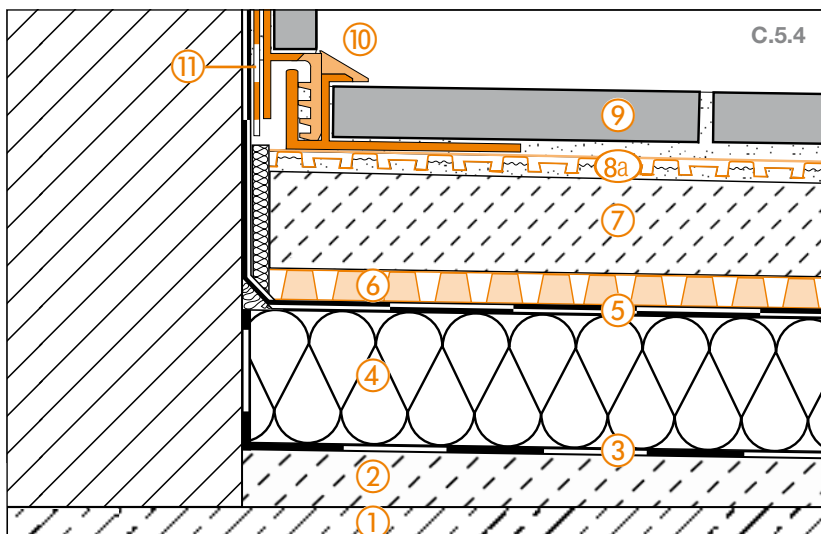

- ① Concrete slab.
- ② Sloped screed (1.5% - 2%).
- ③ Vapour barrier according to DIN 18531.
- ④ Insulation.
- ⑤ Waterproofing assembly according to DIN 18531.
- ⑥ Schlüter®-TROBA-PLUS.
- ⑦ Load distribution layer/screed.
- ⑧a Schlüter®-DITRA-DRAIN 4.
- ⑧b Schlüter®-DITRA-DRAIN 8.
- ⑨ Ceramic tiles or natural stone pavers.
- ⑩ Schlüter®-DILEX-EK.
- ⑪ Schlüter®-KERDI-KEBA.

Threshold

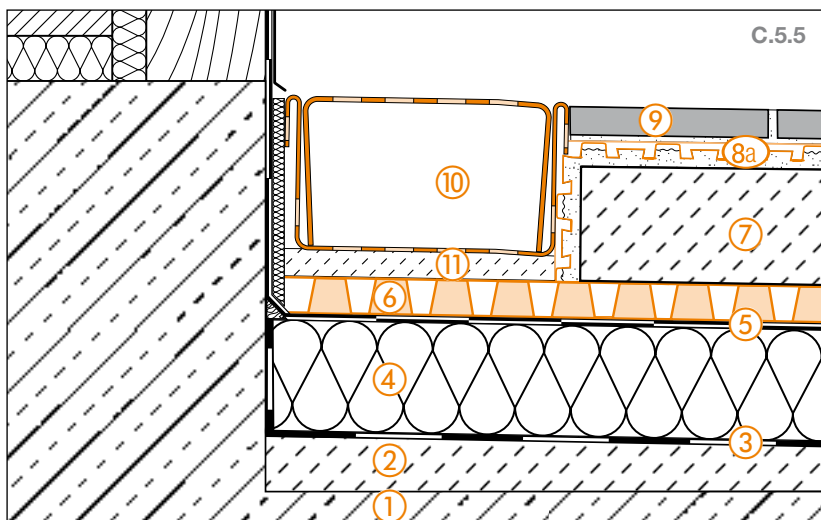

- ① Concrete slab.
- ② Sloped screed (1.5% - 2%).
- ③ Vapour barrier according to DIN 18531.
- ④ Insulation.
- ⑤ Waterproofing assembly according to DIN 18531.
- ⑥ Schlüter®-TROBA-PLUS.
- ⑦ Load distribution layer/screed.
- ⑧a Schlüter®-DITRA-DRAIN 4.
- ⑧b Schlüter®-DITRA-DRAIN 8.
- ⑨ Ceramic tiles or natural stone pavers.
- ⑩ Schlüter®-TROBA-LINE-TL
Keep drainage openings unobstructed.
- ⑪ Mortar spot bedding.

i

For more information on thresholds, please see pages 26 and 27.





Floor drain

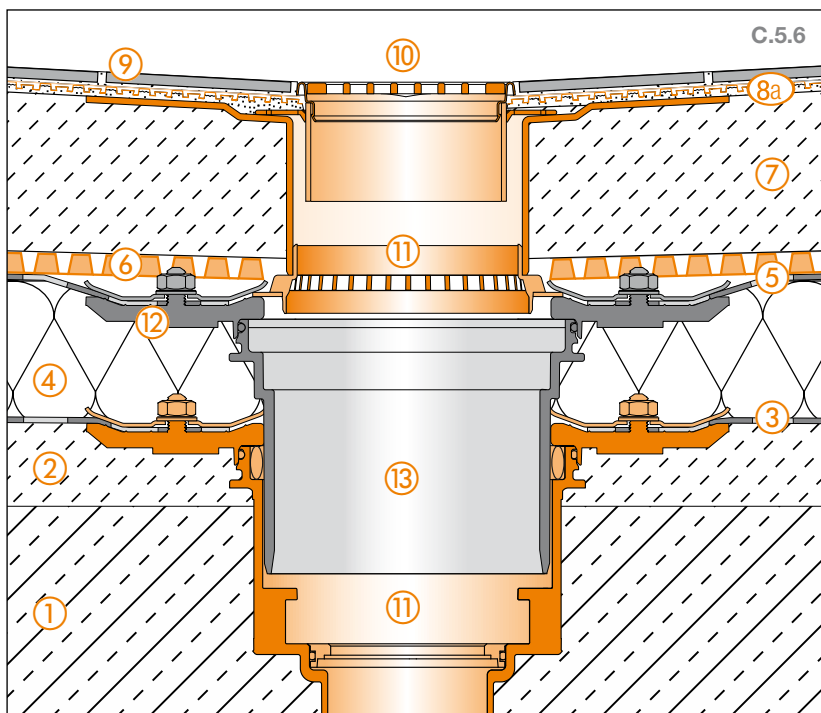

- ① Concrete slab.
- ② Sloped screed (1.5% - 2%).
- ③ Vapour barrier according to DIN 18531.
- ④ Insulation.
- ⑤ Waterproofing assembly according to DIN 18531.
- ⑥ Schlüter®-TROBA-PLUS.
- ⑦ Load distribution layer/screed.
- ⑧a Schlüter®-DITRA-DRAIN 4.
- ⑧b Schlüter®-DITRA-DRAIN 8.
- ⑨ Ceramic tiles or natural stone pavers.
- ⑩ Schlüter®-KERDI-DRAIN
Grate/frame set KD R10
Keep drainage openings unobstructed!
- ⑪ Schlüter®-KERDI-DRAIN
Floor drain set KD BV 50 MSBB
- ⑫ Waterproofing connection (upon request).
- ⑬ Extension for floor drains (upon request).

C.6 Loose installation over Schlüter®-TROBA-PLUS 8G

Using thin bed mortar points with Schlüter®-TROBA-STELZ-DR

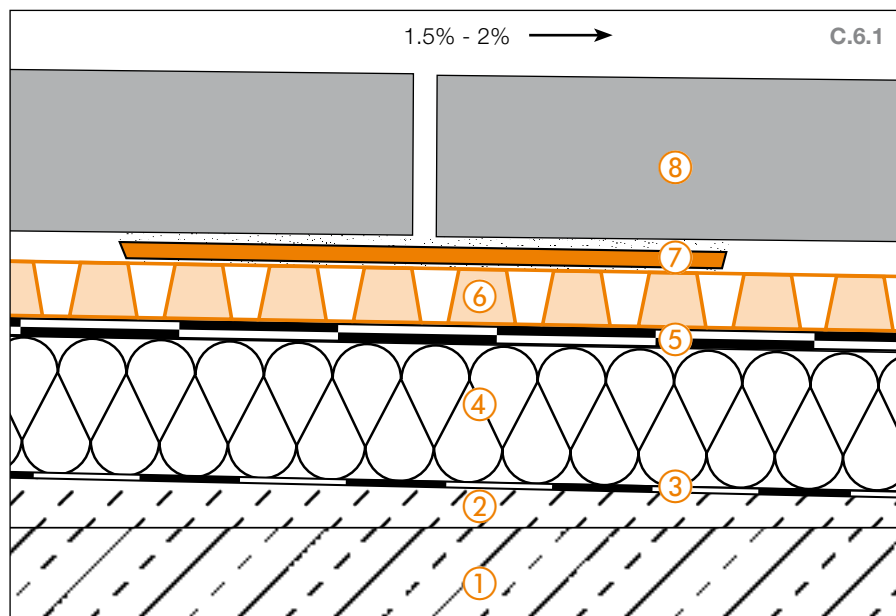

- ① **Concrete slab.**
- ② **Sloped screed**
The construction has to be sufficiently sloped (1.5% - 2%) to allow for proper drainage.
- ③ **Vapour barrier according to DIN 18531.**
- ④ **Insulation**
Thickness according to construction requirements.
- ⑤ **Waterproofing assembly according to DIN 18531.**
- ⑥ **Schlüter®-TROBA-PLUS 8G**
High impact drainage membrane for use underneath self supporting pavers and for permanently effective drainage of water seeping through the open joints between pavers. It is important to ensure a drainage channel.
- ⑦ **Schlüter®-TROBA-STELZ-DR**
Casting mould rings for thin bed screeds.
- ⑧ **Large format self supporting pavers**
Made of concrete, natural stone or ceramic material.

In this type of assembly, the high impact area drainage membrane Schlüter-TROBA-PLUS 8G is installed underneath self supporting pavers and guarantees the efficient drainage of water that seeps through the open joints between the pavers. Schlüter-TROBA-STELZ-DR are used as casting

mould rings to create evenly spaced adhesive points of thin bed mortar for the self supporting pavers.

Note: TROBA-STELZ-DR casting mould rings can be removed after the application of the thin bed screed and reused in other applications.



i

An additional unit of Schlüter-TROBA-STELZ-DR can be installed below the respective centre of the paver if necessary.





Edge detail 1

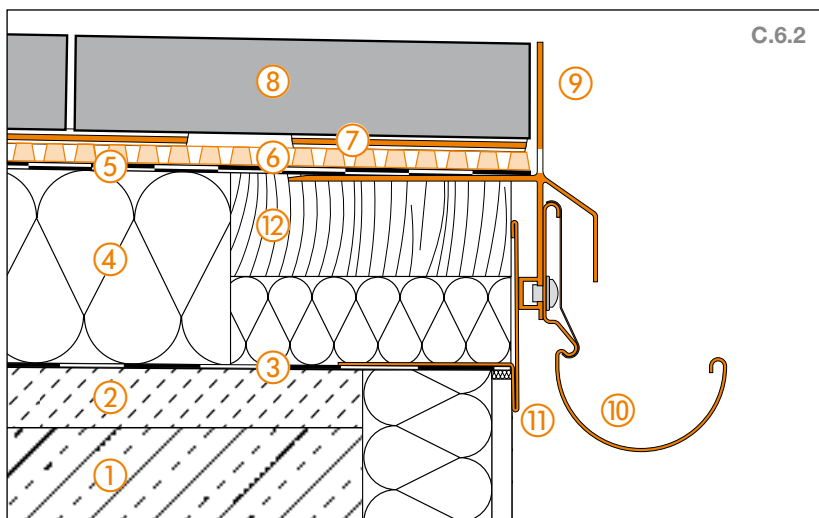

C.6.2

- ① Concrete slab.
- ② Sloped screed (1.5% - 2%).
- ③ Vapour barrier according to DIN 18531.
- ④ Insulation.
- ⑤ Waterproofing assembly according to DIN 18531.
- ⑥ Schlüter®-TROBA-PLUS 8G.
- ⑦ Schlüter®-TROBA-STELZ-DR.
- ⑧ Large format, self supporting pavers.
- ⑨ Schlüter®-BARA-RKLT
Keep drainage openings unobstructed.
- ⑩ Schlüter®-BARIN.
- ⑪ Schlüter®-BARA-RT.
- ⑫ Edge beam.

Edge detail 2

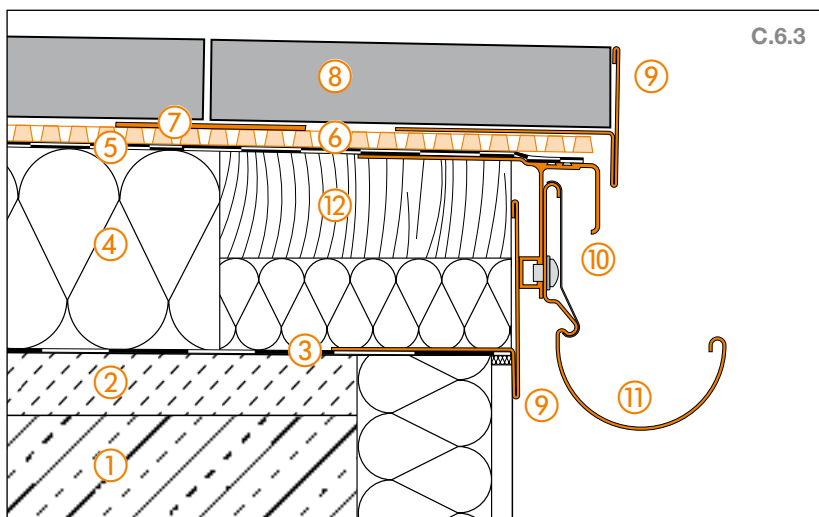

C.6.3

- ① Concrete slab.
- ② Sloped screed (1.5% - 2%).
- ③ Vapour barrier according to DIN 18531.
- ④ Insulation.
- ⑤ Waterproofing assembly according to DIN 18531.
- ⑥ Schlüter®-TROBA-PLUS 8G.
- ⑦ Schlüter®-TROBA-STELZ-DR.
- ⑧ Large format, self supporting pavers.
- ⑨ Schlüter®-BARA-RT
It is important to ensure a drainage channel.
- ⑩ Schlüter®-BARA-RTK.
- ⑪ Schlüter®-BARIN.
- ⑫ Edge beam.

Edge detail 3

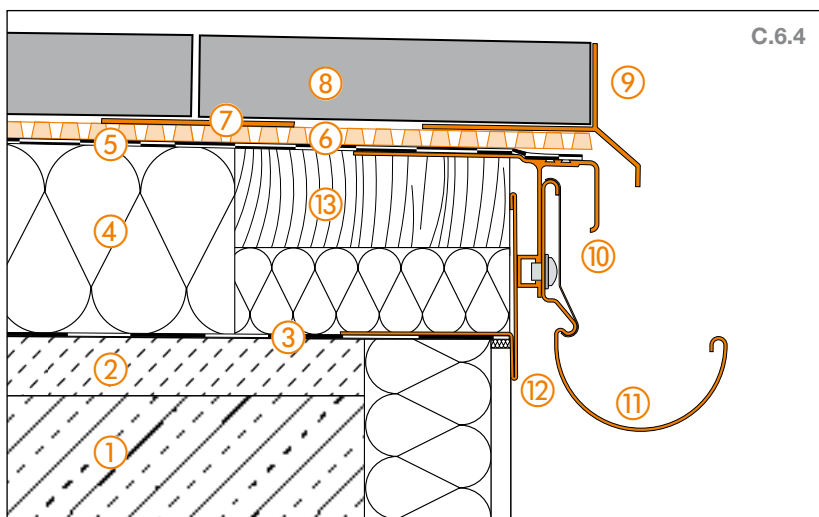

C.6.4

- ① Concrete slab.
- ② Sloped screed (1.5% - 2%).
- ③ Vapour barrier according to DIN 18531.
- ④ Insulation.
- ⑤ Waterproofing assembly according to DIN 18531.
- ⑥ Schlüter®-TROBA-PLUS 8G.
- ⑦ Schlüter®-TROBA-STELZ-DR.
- ⑧ Large format, self supporting pavers.
- ⑨ Schlüter®-BARA-RK
It is important to ensure a drainage channel.
- ⑩ Schlüter®-BARA-RTK.
- ⑪ Schlüter®-BARIN.
- ⑫ Schlüter®-BARA-RT.
- ⑬ Edge beam.



Edge detail 4

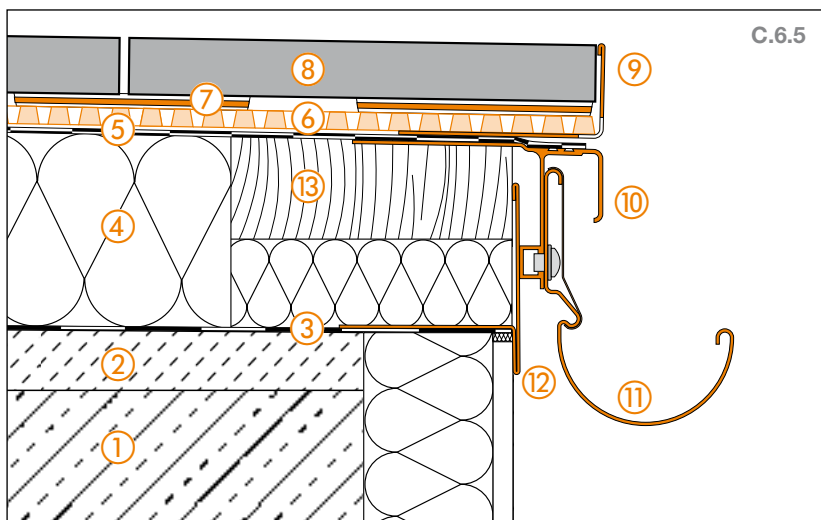

- ① Concrete slab.
- ② Sloped screed (1.5% - 2%).
- ③ Vapour barrier according to DIN 18531.
- ④ Insulation.
- ⑤ Waterproofing assembly according to DIN 18531.
- ⑥ Schlüter®-TROBA-PLUS 8G.
- ⑦ Schlüter®-TROBA-STELZ-DR.
- ⑧ Large format, self supporting pavers.
- ⑨ Schlüter®-BARA-RWL
Keep drainage openings unobstructed.
- ⑩ Schlüter®-BARA-RTK.
- ⑪ Schlüter®-BARIN.
- ⑫ Schlüter®-BARA-RT.
- ⑬ Edge beam.

Wall transition

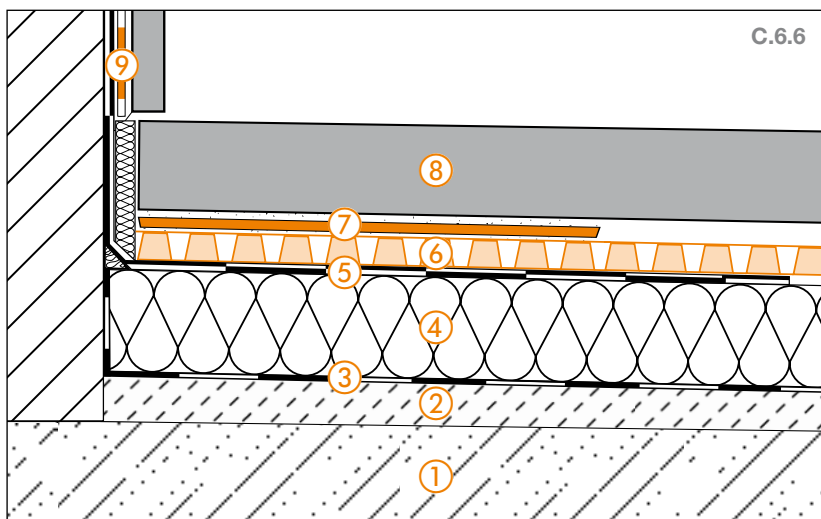

- ① Concrete slab.
- ② Sloped screed (1.5% - 2%).
- ③ Vapour barrier according to DIN 18531.
- ④ Insulation.
- ⑤ Waterproofing assembly according to DIN 18531.
- ⑥ Schlüter®-TROBA-PLUS 8G.
- ⑦ Schlüter®-TROBA-STELZ-DR.
- ⑧ Large format, self supporting pavers.
- ⑨ Schlüter®-KERDI.

Threshold

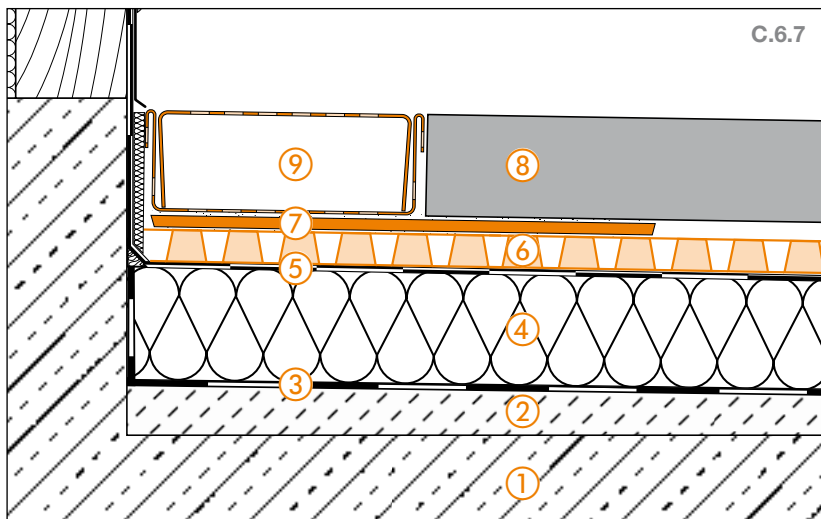

- ① Concrete slab.
- ② Sloped screed (1.5% - 2%).
- ③ Vapour barrier according to DIN 18531.
- ④ Insulation.
- ⑤ Waterproofing assembly according to DIN 18531.
- ⑥ Schlüter®-TROBA-PLUS 8G.
- ⑦ Schlüter®-TROBA-STELZ-DR.
- ⑧ Large format, self supporting pavers.
- ⑨ Schlüter®-TROBA-LINE-TL.



For more information on thresholds, please see pages 26 and 27.





C.7 Covering assemblies over mortar stilts

Installation with Schlüter®-TROBA-STELZ mortar casting mould rings

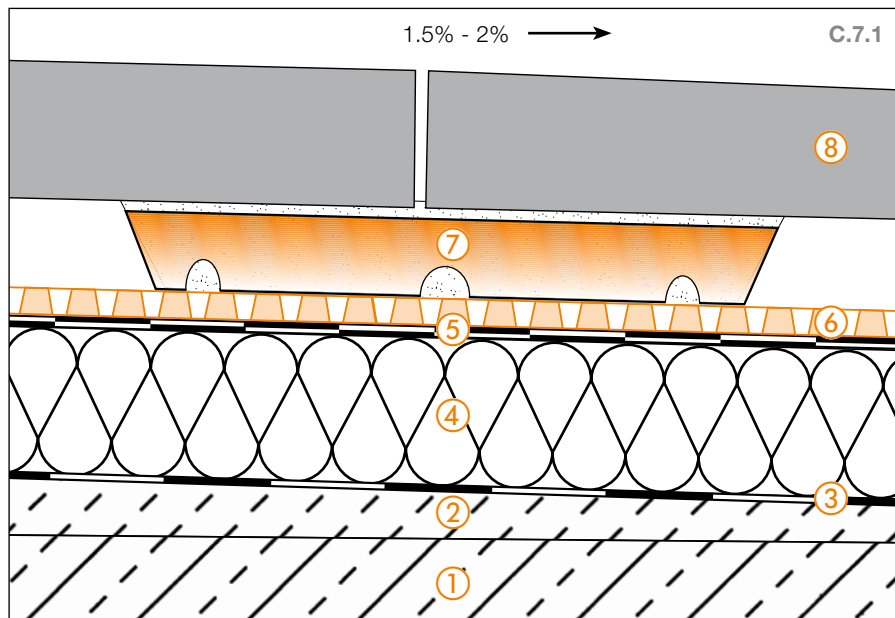

- ① **Concrete slab.**
- ② **Sloped screed**
The construction has to be sufficiently sloped (1.5% - 2%) to allow for proper drainage.
- ③ **Vapour barrier according to DIN 18531.**
- ④ **Insulation**
Thickness according to construction requirements.
- ⑤ **Waterproofing assembly according to DIN 18531.**
- ⑥ **Schlüter®-TROBA-PLUS 8G**
High impact drainage membrane for use underneath self supporting pavers and for permanently effective drainage of water seeping through the open joints between pavers. It is important to ensure a drainage channel.
- ⑦ **Schlüter®-TROBA-STELZ-MR**
Plastic casting mould rings that are used as installation aids for large format pavers on balconies and terraces.
- ⑧ **Large format self supporting pavers**
Made of concrete, natural stone or ceramic material.

Schlüter-TROBA-STELZ-MR are plastic casting mould rings that are used as installation aids for large format pavers. The 25 mm high plastic rings are installed at the cross sections of the pavers and remain in the assembly once they have been filled with fresh mortar (preferably pervious mortar).

This allows for easy levelling of the covering surface. Additionally, the open spaces between the stilts ensure the fast drainage of water that seeps into the joints between the pavers.



i

An additional unit of Schlüter-TROBA-STELZ-MR can be installed below the respective centre of the paver if necessary.



Edge detail 1

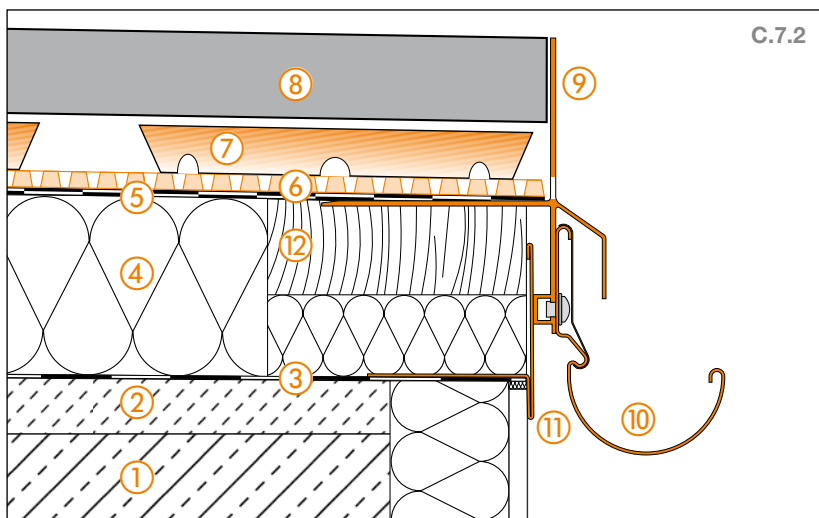

- ① Concrete slab.
- ② Sloped screed (1.5% - 2%).
- ③ Vapour barrier according to DIN 18531.
- ④ Insulation.
- ⑤ Waterproofing assembly according to DIN 18531.
- ⑥ Schlüter®-TROBA-PLUS 8G.
- ⑦ Schlüter®-TROBA-STELZ-MR.
- ⑧ Large format, self supporting pavers.
- ⑨ Schlüter®-BARA-RKLT
Keep drainage openings unobstructed.
- ⑩ Schlüter®-BARIN.
- ⑪ Schlüter®-BARA-RT.
- ⑫ Edge beam.

Edge detail 2

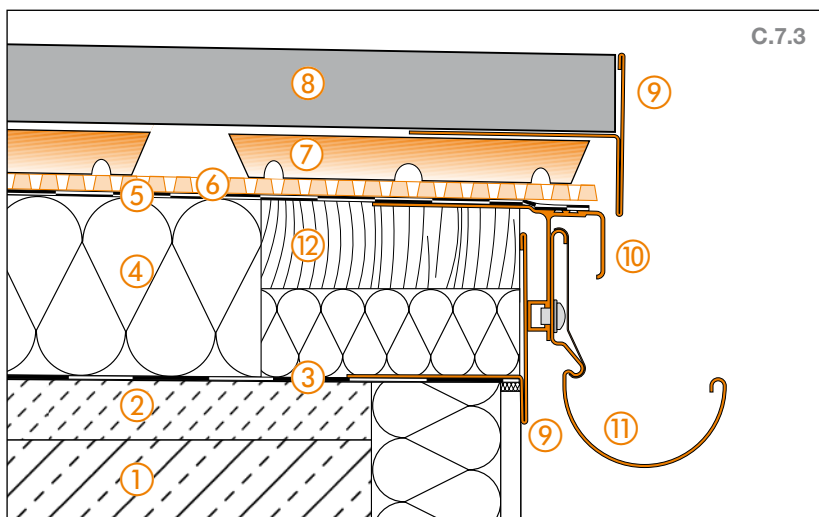

- ① Concrete slab.
- ② Sloped screed (1.5% - 2%).
- ③ Vapour barrier according to DIN 18531.
- ④ Insulation.
- ⑤ Waterproofing assembly according to DIN 18531.
- ⑥ Schlüter®-TROBA-PLUS 8G.
- ⑦ Schlüter®-TROBA-STELZ-MR.
- ⑧ Large format, self supporting pavers.
- ⑨ Schlüter®-BARA-RT
It is important to ensure a drainage channel.
- ⑩ Schlüter®-BARA-RTK.
- ⑪ Schlüter®-BARIN.
- ⑫ Edge beam.

Edge detail 3

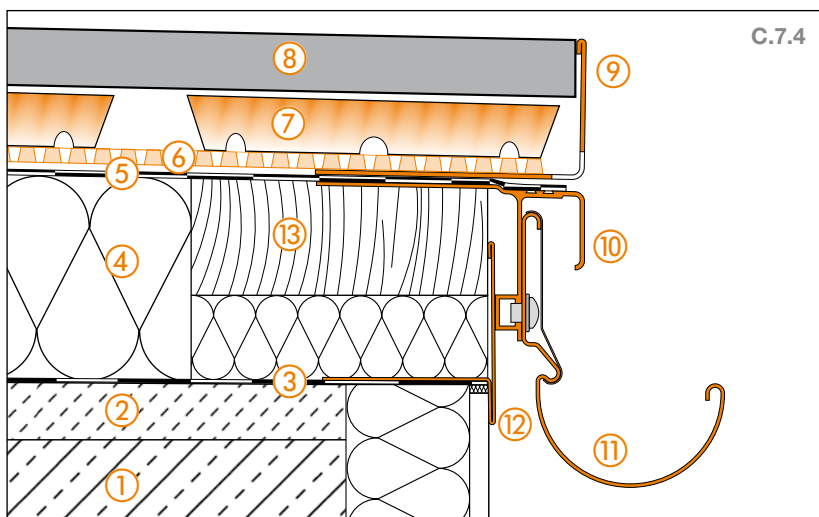

- ① Concrete slab.
- ② Sloped screed (1.5% - 2%).
- ③ Vapour barrier according to DIN 18531.
- ④ Insulation.
- ⑤ Waterproofing assembly according to DIN 18531.
- ⑥ Schlüter®-TROBA-PLUS 8G.
- ⑦ Schlüter®-TROBA-STELZ-MR.
- ⑧ Large format, self supporting pavers.
- ⑨ Schlüter®-BARA-RWL
Keep drainage openings unobstructed.
- ⑩ Schlüter®-BARA-RTK.
- ⑪ Schlüter®-BARIN.
- ⑫ Schlüter®-BARA-RT.
- ⑬ Edge beam.





Wall transition

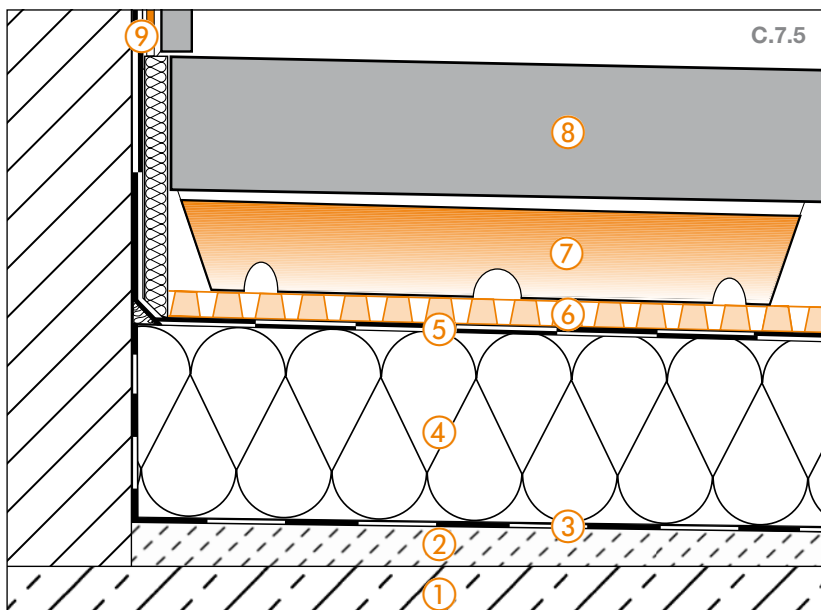

- ① Concrete slab.
- ② Sloped screed (1.5% - 2%).
- ③ Vapour barrier according to DIN 18531.
- ④ Insulation.
- ⑤ Waterproofing assembly according to DIN 18531.
- ⑥ Schlüter®-TROBA-PLUS 8G.
- ⑦ Schlüter®-TROBA-STELZ-MR.
- ⑧ Large format, self supporting pavers.
- ⑨ Schlüter®-KERDI.

Threshold

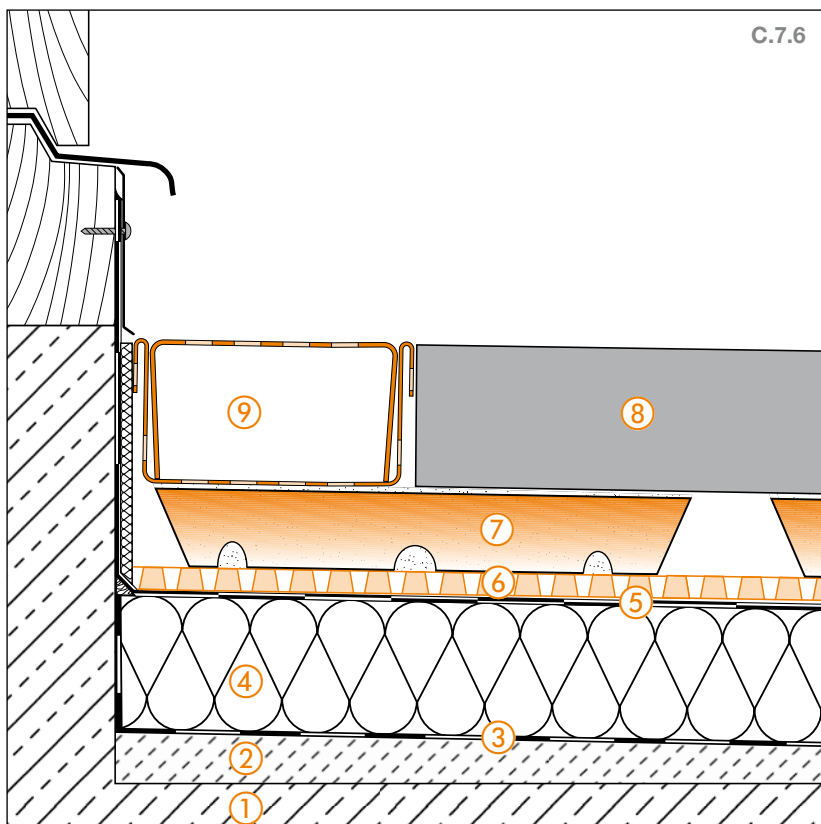

- ① Concrete slab.
- ② Sloped screed (1.5% - 2%).
- ③ Vapour barrier according to DIN 18531.
- ④ Insulation.
- ⑤ Waterproofing assembly according to DIN 18531.
- ⑥ Schlüter®-TROBA-PLUS 8G.
- ⑦ Schlüter®-TROBA-STELZ-MR.
- ⑧ Large format, self supporting pavers.
- ⑨ Schlüter®-TROBA-LINE-TL.

i

For more information on thresholds, please see pages 26 and 27.

C.8 Coverings installed over gravel/crushed stone beds

Loose installation on Schlüter®-TROBA in gravel/crushed stone beds

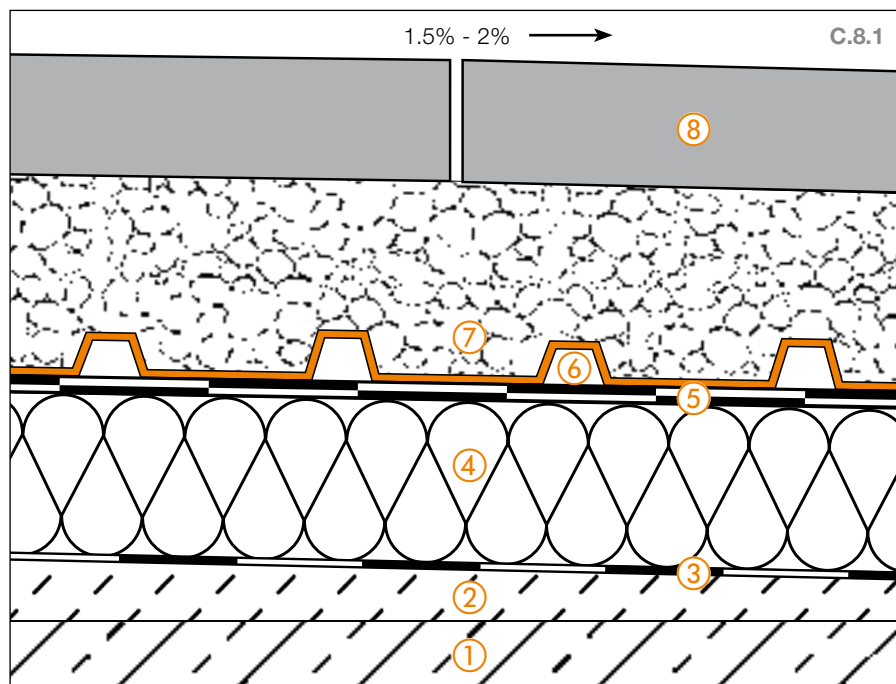

- ① **Concrete slab.**
- ② **Sloped screed**
The construction has to be sufficiently sloped (1.5% - 2%) to allow for proper drainage.
- ③ **Vapour barrier according to DIN 18531.**
- ④ **Insulation**
Thickness according to construction requirements.
- ⑤ **Waterproofing assembly according to DIN 18531.**
- ⑥ **Schlüter®-TROBA**
A protective drainage layer installed over waterproofing assemblies as an underlayment for crushed stone or gravel. It consists of a high impact, studded polyethylene mat with openings to the drainage channels. It is important to ensure a drainage channel.
- ⑦ **Gravel or crushed stone bed.**
- ⑧ **Large format self supporting pavers**
Made of concrete, natural stone or ceramic material.

In this type of assembly, the area drainage membrane Schlüter-TROBA serves as a protective separating layer over the waterproofing assembly and protects it from the impression of individual stones. Additionally, the product prevents the formation of "ice concrete" when water freezes on the water-

proofing assembly. TROBA allows for the permanently effective drainage of water that seeps through the open joints between the self supporting pavers. Thanks to the special trapezoid shaped studs, loads are directly transferred to the waterproof substrate.





Edge detail 1

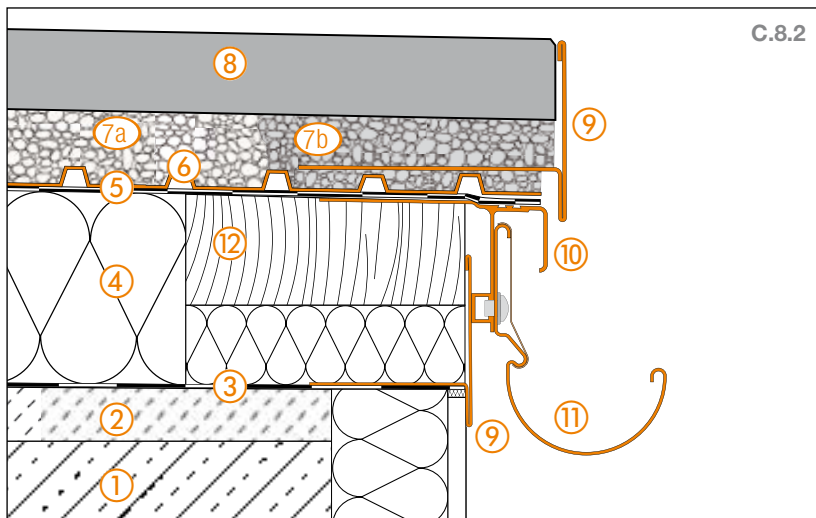

C.8.2

- ① Concrete slab.
- ② Sloped screed (1.5% - 2%).
- ③ Vapour barrier according to DIN 18531.
- ④ Insulation.
- ⑤ Waterproofing assembly according to DIN 18531.
- ⑥ Schlüter®-TROBA.
- ⑦a Gravel or crushed stone bed.
- ⑦b Contained gravel or crushed stone bed in the perimeter area.
- ⑧ Large format, self supporting pavers.
- ⑨ Schlüter®-BARA-RT
It is important to ensure a drainage channel.
- ⑩ Schlüter®-BARA-RTK.
- ⑪ Schlüter®-BARIN.
- ⑫ Edge beam.

Edge detail 2

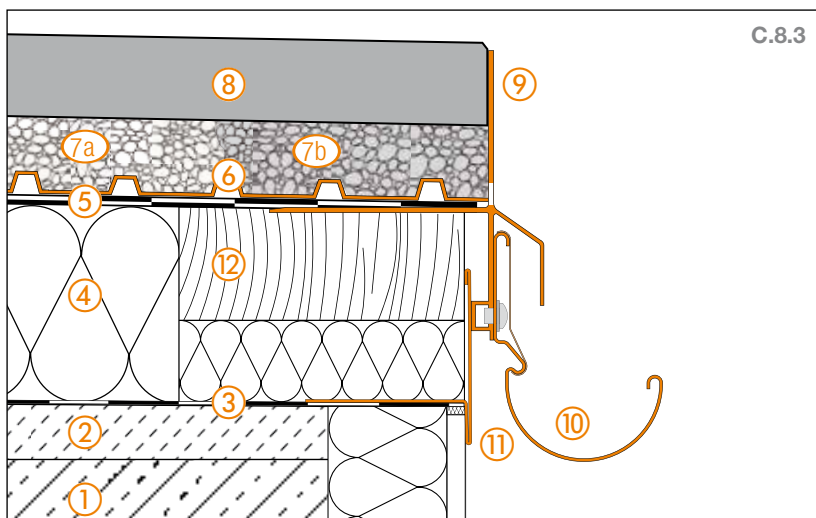

C.8.3

- ① Concrete slab.
- ② Sloped screed (1.5% - 2%).
- ③ Vapour barrier according to DIN 18531.
- ④ Insulation.
- ⑤ Waterproofing assembly according to DIN 18531.
- ⑥ Schlüter®-TROBA.
- ⑦a Gravel or crushed stone bed.
- ⑦b Contained gravel or crushed stone bed in the perimeter area.
- ⑧ Large format, self supporting pavers.
- ⑨ Schlüter®-BARA-RKLT
Keep drainage openings unobstructed.
- ⑩ Schlüter®-BARIN.
- ⑪ Schlüter®-BARA-RT.
- ⑫ Edge beam.

Edge detail 3

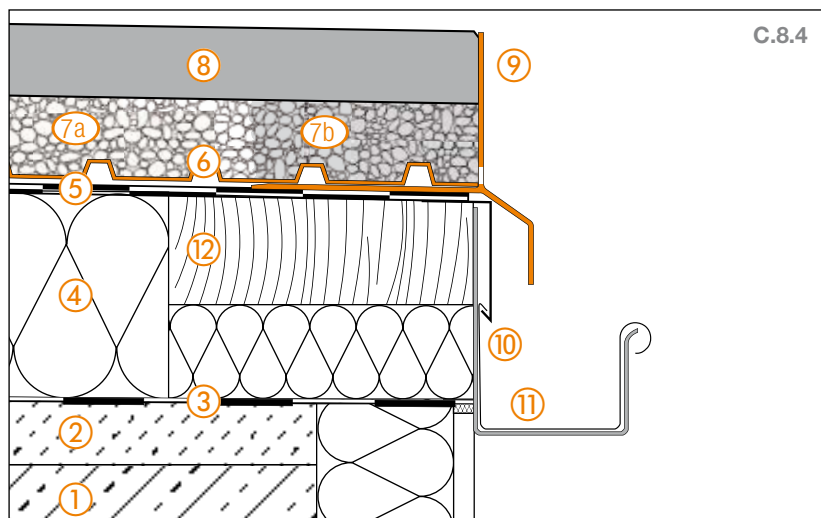

- ① Concrete slab.
- ② Sloped screed (1.5% - 2%).
- ③ Vapour barrier according to DIN 18531.
- ④ Insulation.
- ⑤ Waterproofing assembly according to DIN 18531.
- ⑥ Schlüter®-TROBA.
- ⑦a Gravel or crushed stone bed.
- ⑦b Contained gravel or crushed stone bed in the perimeter area.
- ⑧ Large format, self supporting pavers.
- ⑨ Schlüter®-BARA-RKL
Keep drainage openings unobstructed.
- ⑩ Eave flashing.
- ⑪ DIN compliant gutter.
- ⑫ Edge beam.

Edge detail 4

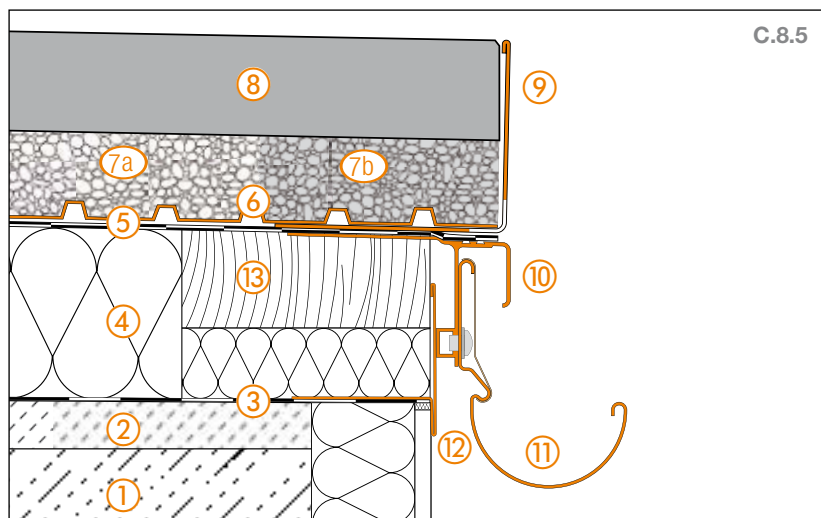

- ① Concrete slab.
- ② Sloped screed (1.5% - 2%).
- ③ Vapour barrier according to DIN 18531.
- ④ Insulation.
- ⑤ Waterproofing assembly according to DIN 18531.
- ⑥ Schlüter®-TROBA.
- ⑦a Gravel or crushed stone bed.
- ⑦b Contained gravel or crushed stone bed in the perimeter area.
- ⑧ Large format, self supporting pavers.
- ⑨ Schlüter®-BARA-RWL
Keep drainage openings unobstructed.
- ⑩ Schlüter®-BARA-RTK.
- ⑪ Schlüter®-BARIN.
- ⑫ Schlüter®-BARA-RT.
- ⑬ Edge beam.





Wall transition

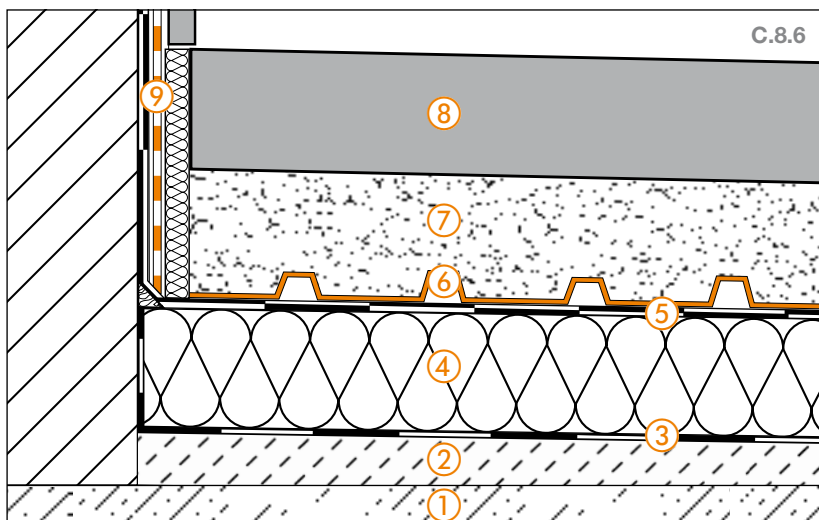

- ① Concrete slab.
- ② Sloped screed (1.5% - 2%).
- ③ Vapour barrier according to DIN 18531.
- ④ Insulation.
- ⑤ Waterproofing assembly according to DIN 18531.
- ⑥ Schlüter®-TROBA.
- ⑦ Gravel or crushed stone bed.
- ⑧ Large format, self supporting pavers.
- ⑨ Schlüter®-KERDI.

Threshold

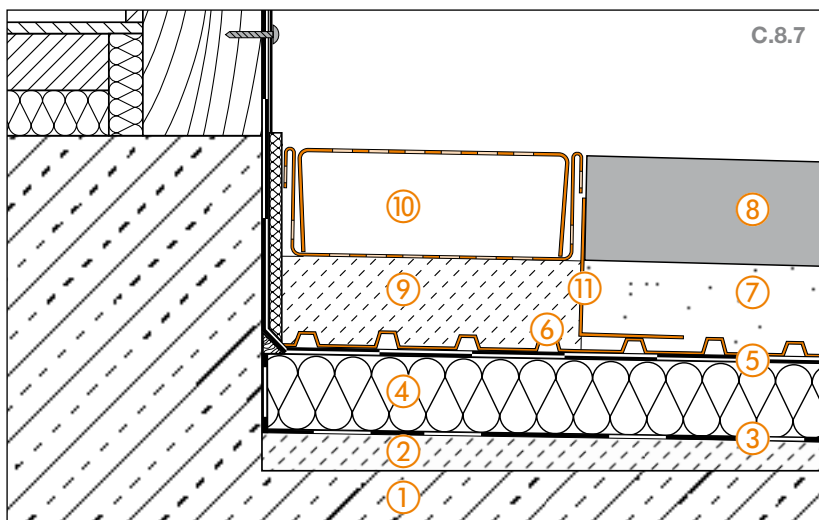

- ① Concrete slab.
- ② Sloped screed (1.5% - 2%).
- ③ Vapour barrier according to DIN 18531.
- ④ Insulation.
- ⑤ Waterproofing assembly according to DIN 18531.
- ⑥ Schlüter®-TROBA.
- ⑦ Gravel or crushed stone bed.
- ⑧ Large format, self supporting pavers.
- ⑨ Mortar spot bedding.
- ⑩ Schlüter®-TROBA-LINE-TL.
- ⑪ Schlüter®-TROBA-LINE-TLK-E gravel containment profile.

i

For more information on thresholds, please see pages 26 and 27.

C.9 Other details

Edge drainage

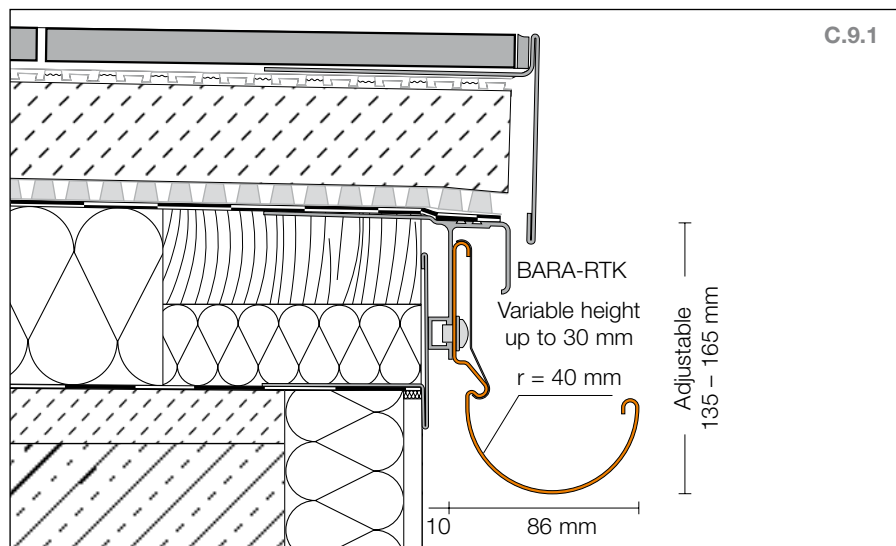

Schlüter-BARIN is a gutter system of colour coated aluminium for the drainage of balconies and terraces. It is designed for attachment to the corresponding Schlüter-BARA profiles.

Perimeter drainage systems are quick and easy to install with the BARIN gutter system.

Schlüter®-BARIN gutter system

- ① Gutter 2.50 m
- ② End cap
- ③ Exterior corner 90°
- ④ Exterior corner 135°
- ⑤ Interior corner 90°
- ⑥ Interior corner 135°
- ⑦ Gutter unit 20 cm with connection to downspout
- ⑧ Gutter cover profile
- ⑨ Gutter connector
- ⑩ Corner cover profile
- ⑪ Exterior corner with left-side drain
- ⑫ Exterior corner with right-side drain

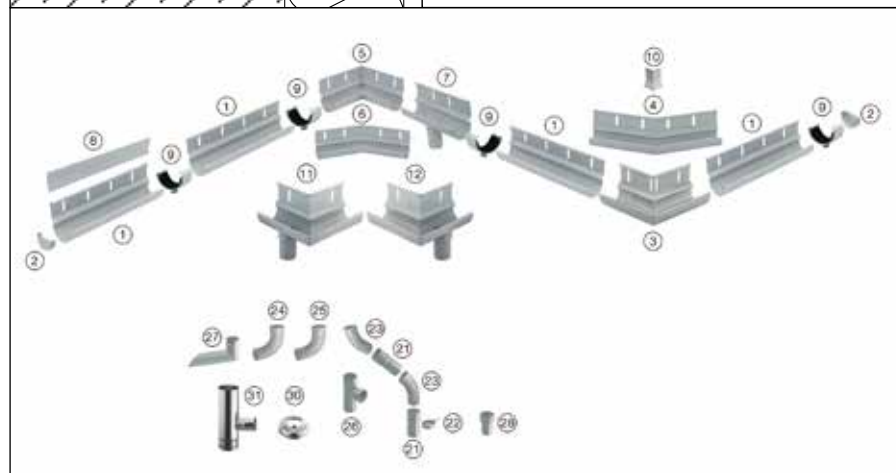

Schlüter®-BARIN pipe system

- ⑲ Down pipe Ø 60 mm
- ⑳ Pipe clamp
- ㉑ Elbow pipe 40°
- ㉒ Elbow pipe 72°
- ㉓ Elbow pipe 85°
- ㉔ Tee pipe 72°
- ㉕ Spout
- ㉖ Clip-on connector
- ㉗ Downpipe cap Ø 60 mm
- ㉘ Tee pipe zinc/copper

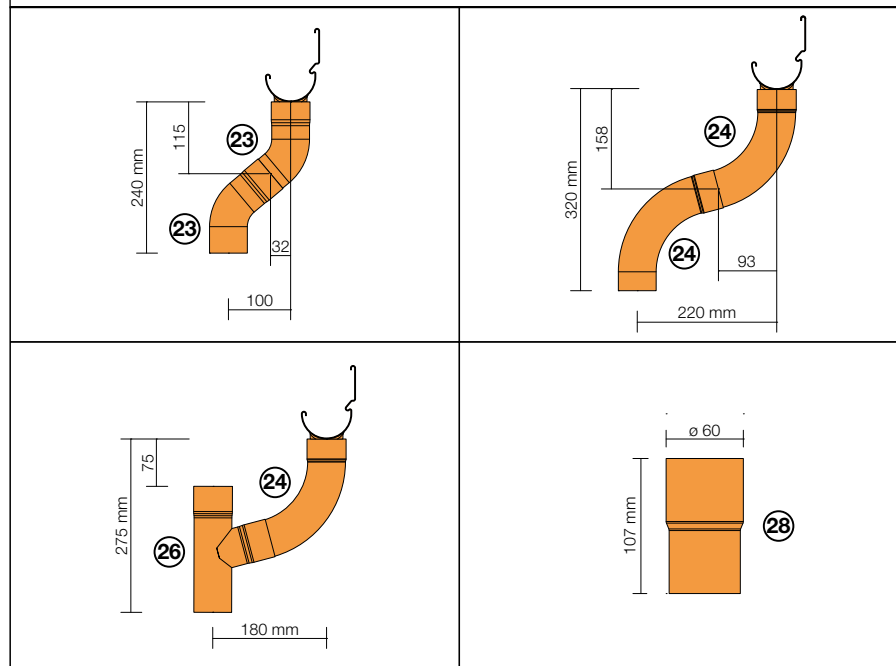



Threshold

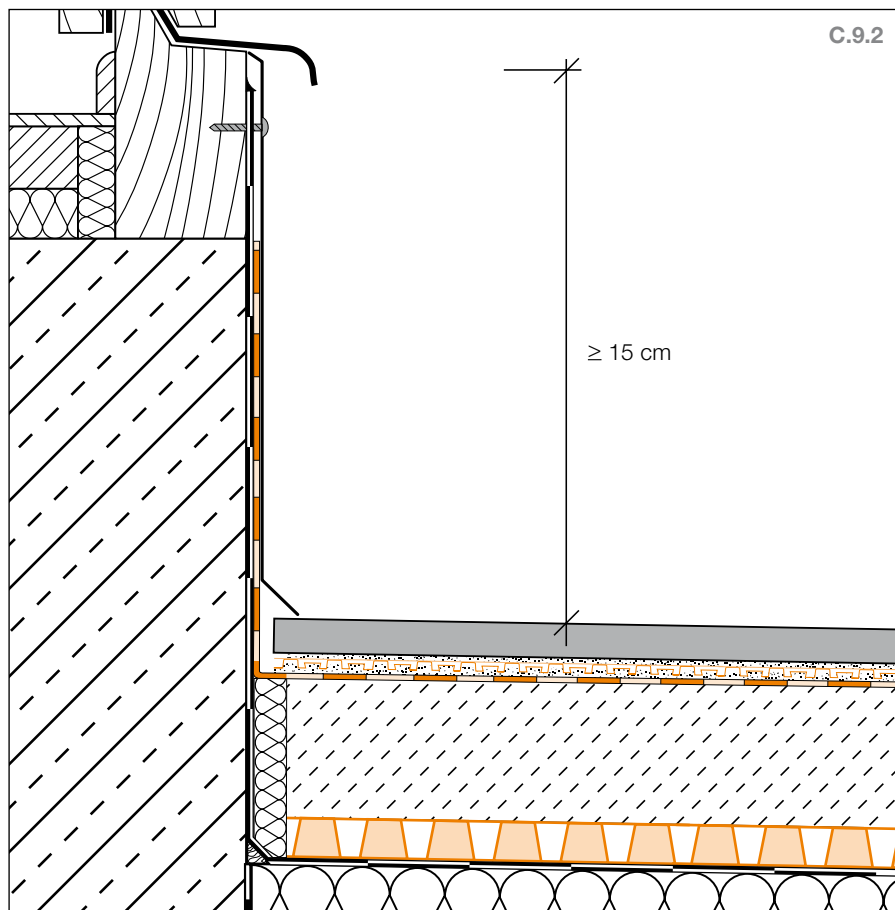

According to DIN 18531-5, 8.6, waterproofing assemblies must extend 15 cm beyond the upper edge of the covering. In door transition areas, this rule results in thresholds that are at least 15 cm high.

Drainage/thresholds

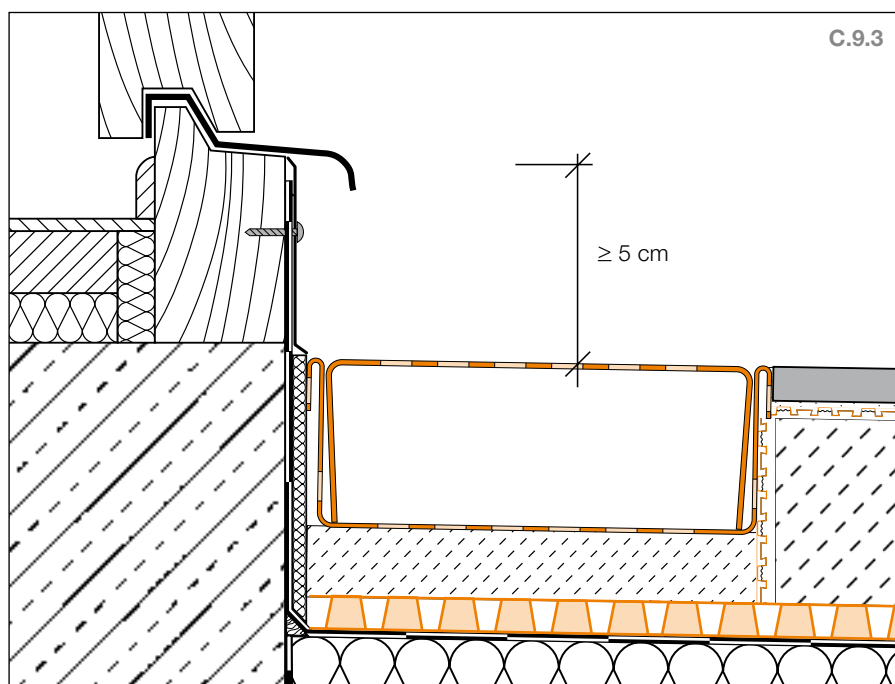

Schlüter-TROBA-LINE is a drainage channel that prevents water from pooling near doorways and wall transitions. According to construction guidelines for flat roofs, the product can therefore be used to reduce the height of DIN compliant thresholds from 15 cm to 5 cm.

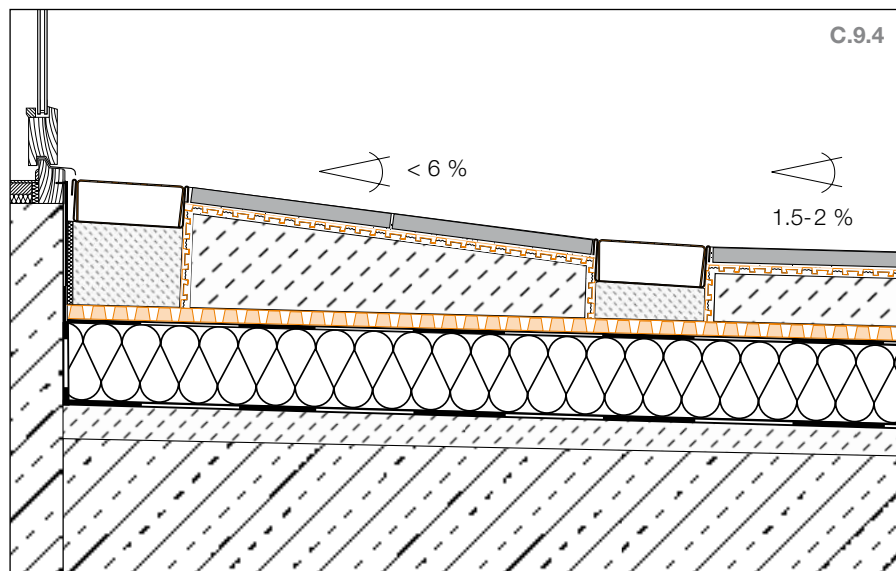

Barrier free assembly

Schlüter-TROBA-LINE is suitable for creating barrier free assemblies (with thresholds below 2 cm) in the area of door openings. In these assemblies, a second TROBA-LINE profile is installed at a sufficiently large distance from the first. Special constructions such as this assembly require the prior approval of the developer.



Movement joints

In accordance with the applicable construction standards, movement joints must be continued in the tile covering. The same standards specify that coverings made of large format pavers over Schlüter-DITRA and Schlüter-DITRA-DRAIN must be divided into bays with movement joints. In outdoor

areas (balconies and terraces) the length of these individual bays should not exceed 3 m. Depending on the construction of the substrate, smaller bays may be necessary. The bays should be of compact geometric dimensions (up to a ratio of approximately 1:2). Please refer to the installation infor-

mation for the various profile types in the Schlüter-DILEX series. Depending on the anticipated movements, profiles such as Schlüter-DILEX-BT or Schlüter-DILEX-KSBT should be installed over structural movement joints.

Movement joints

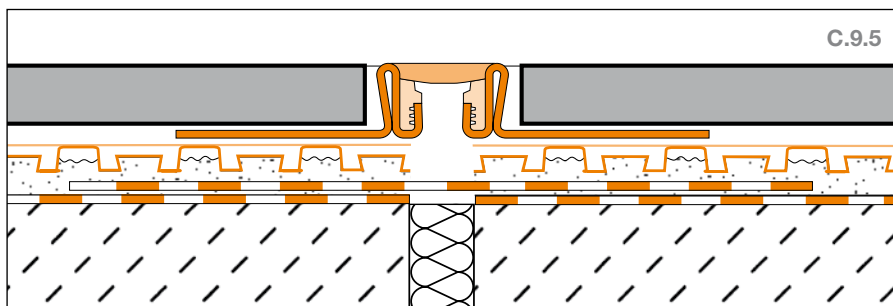

Schlüter-DITRA-DRAIN must be separated above the existing movement joints. If Schlüter-KERDI is used for waterproofing, the abutting seams must be covered with Schlüter-KERDI-FLEX, using the sealing adhesive Schlüter-KERDI-COLL-L.

Schlüter-DILEX-EKSN is a movement profile with edge protection. The profile's anchoring legs, made of stainless steel, are connected to a movement zone made of soft synthetic rubber.

Movement joints

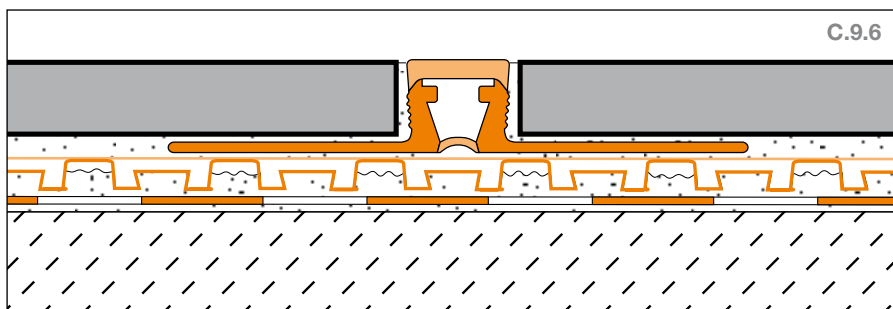

Schlüter-DILEX-BWB is a movement profile with lateral parts made of rigid recycled PVC. The upper movement zone is made of soft rubber and forms a 10 mm wide visible area.

i

The ceramic covering must be divided into bays with movement joints above Schlüter-DITRA and Schlüter-DITRA-DRAIN in accordance with the applicable regulations. This also applies if the substrates were created without movement joints, for example in our Schlüter-BEKOTEC-DRAIN system.



Skirting

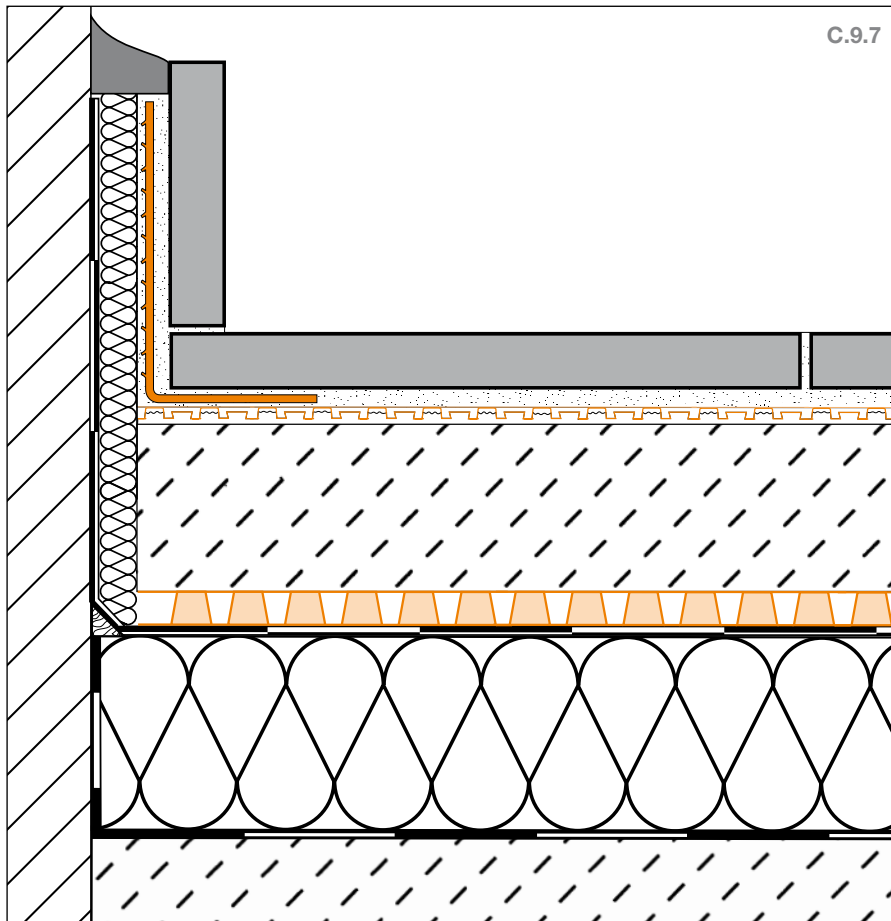

Schlüter-BARA-ESOT is a skirting support profile made of stainless steel for bonding skirting tiles that are not load bearing. An area drainage membrane (Schlüter-TROBA-PLUS) must be installed below the screed.



Profile cross sections

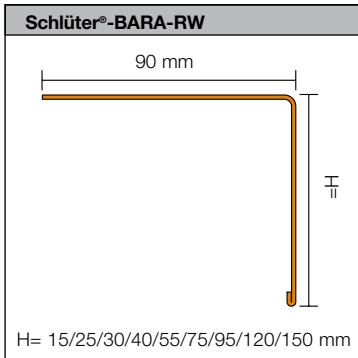

Product data sheet 5.3

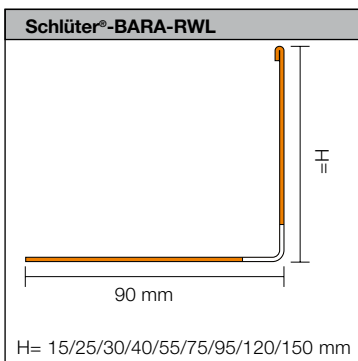
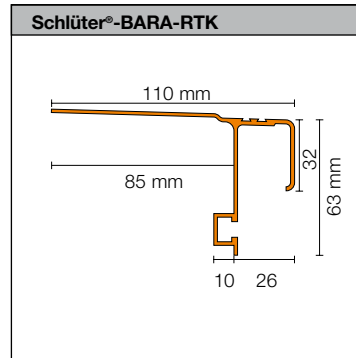
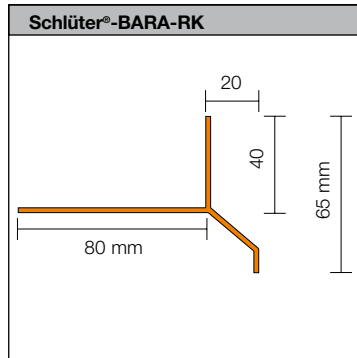

Product data sheet 5.15

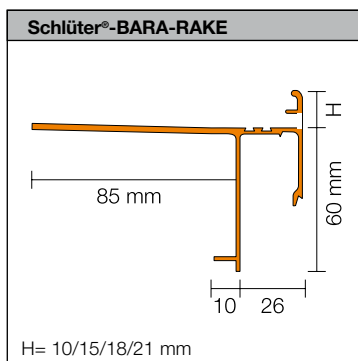
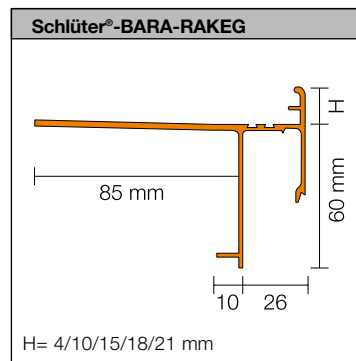
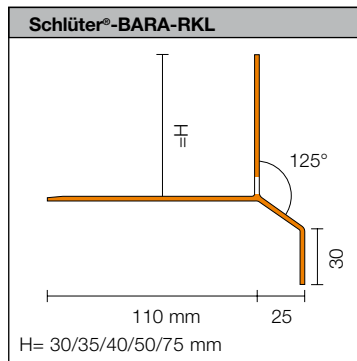
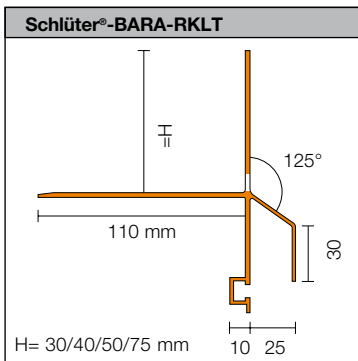
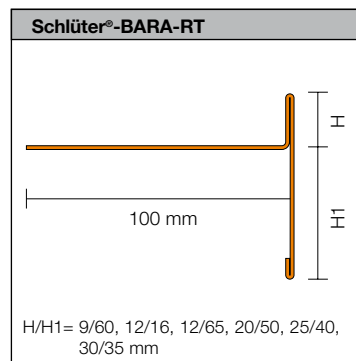
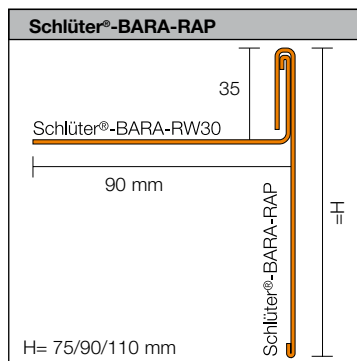

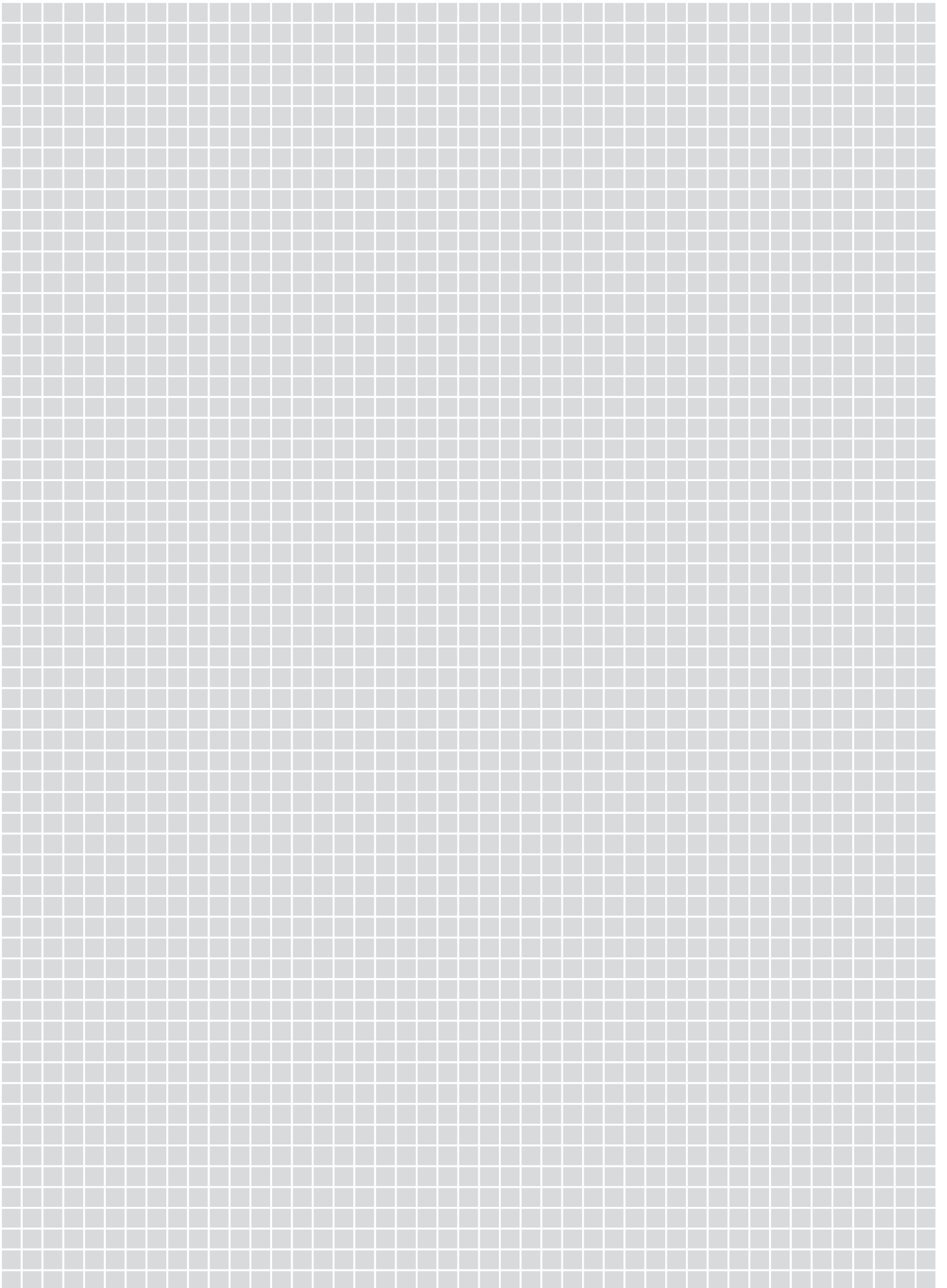



PROFILE OF INNOVATION

Schlüter-Systems KG · Schmölestraße 7 · D-58640 Iserlohn
Tel.: +49 2371 971-0 · Fax: +49 2371 971-1111 · info@schlueter.de · schlueter-systems.com