

# Schlüter®-DILEX-EMP

Movement joint profile  
for mortar bed applications

# 4.17

Product data sheet



## Application and Function

**Schlüter®-DILEX-EMP** is a maintenance-free, stainless steel movement profile for absorbing horizontal movement. The profile is especially suited for heavily used tile and natural stone surfaces set into mortar beds. Schlüter®-DILEX-EMP offers secure edge protection for surfaces exposed to continuous vehicular traffic and is, therefore, suited for use in warehouses, shopping centres, underground car parks, or for floor surfaces maintained with cleaning machines.

The profile system is used for producing expansion joints in surface coverings made of quarry or ceramic tile, as well as natural or agglomerate stone, set into mortar beds. Movements within the floor covering are absorbed by the tongue-and-groove connection.

The profile cannot absorb vertical movement. The visible width of the Schlüter®-DILEX-EMP profile in its base position is 12 mm.

## Material

Schlüter®-DILEX-EMP is available in the following material:

E = stainless steel V2A,  
material no. 1.4301 = AISI 304



## Material properties and areas of application

Schlüter®-DILEX-EMP is made of stainless steel material no. 1.4301, which is roll-formed from strip metal. Aligned holes are punched into the central area of the profile. The profile is highly durable and especially suited for application areas that must be resistant to chemicals and acids, such as the food industry, breweries, dairies, industrial kitchens, and hospitals as well as residential spaces.

Even stainless steel is not resistant to all chemical stresses, and may be affected, e.g., by hydrochloric and hydrofluoric acid or certain chloride and brine concentrations. In certain cases, this also applies to seawater pools. Special anticipated stresses should therefore be verified in advance.

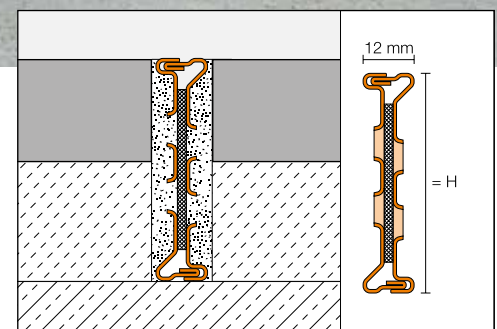



## Installation

1. Select Schlüter®-DILEX-EMP in accordance with the height of the overall floor assembly.
2. Set the profile flush against the edge of a completed field of surface covering (Note: The profile should not be higher than the tile, but rather flush or up to approx. 1 mm lower). The side section of the profile must be adhered to the mortar bed with a slurry coat.
3. Set the adjoining field of the surface covering flush against the profile, ensuring solid coverage.
4. Leave a joint of approx. 2 mm between the tile covering and the profile; fill the joint completely with grout.

## Maintenance

Schlüter®-DILEX-EMP requires no special maintenance or care. Stainless steel surfaces exposed to the environment or aggressive substances should be cleaned periodically using a mild household cleaner. Regular cleaning maintains the neat appearance of stainless steel and reduces the risk of corrosion. All cleaning agents must be free of hydrochloric and hydrofluoric acid. Avoid contact with other metals such as steel, since this can cause extraneous rust. This also includes tools such as trowels or steel wool, i.e., tools used to remove mortar residue. We recommend the use of the stainless steel cleaning polish Schlüter®-CLEAN-CP.



### Text template for tenders:

\_\_\_\_\_ linear metres of Schlüter®-DILEX-EMP, as a movement profile made of stainless steel, with a top and bottom tongue and groove connection, and a perforated centre section to absorb horizontal movement in surface coverings set into mortar beds:

... to be supplied and professionally installed flush with the surface covering while observing the manufacturer's instructions.

Profile height: \_\_\_\_\_ mm  
 Art.-No.: \_\_\_\_\_  
 Material: \_\_\_\_\_/m  
 Labour: \_\_\_\_\_/m  
 Total: \_\_\_\_\_/m

## Product Overview







### Schlüter®-DILEX-EMP

EMP = Stainless steel screed profile

Length supplied: 2.50 m

Material	EMP
H = 35 mm	•
H = 50 mm	•
H = 65 mm	•

## Application areas depending on local traffic load

- 
**Foot traffic**  
 Total weight —
- 
**Shopping carts**  
 Total weight max. 0.4 t
- 
**Cars**  
 Total weight max. 3.5 t
- 
**Trucks**  
 Total weight max. 40 t
- 
**Forklifts**  
*Pneumatic tyres*  
 Total weight max. 5 t  
*Solid rubber tyres*  
 Total weight max. 2.5 t
- 
**Pallet trucks**  
*Hard rubber tyres*  
 Total weight max. 2.5 t  
 (Pallet trucks must have tandem axles)

- Suitable
- Unsuitable