

Base module Control

Art.-No.: BTEBC



Operating instructions



PROFILE OF INNOVATION

1. About these operating instructions

1.1 About these operating instructions

These operating instructions describe the base module Control "BTEBC" (also referred to as "product" in these operating instructions). These operating instructions are part of the product.

- You should only use the product if you have fully read and understood these operating instructions.
- Verify that these operating instructions are always accessible for any type of work performed on or with the product.
- Pass these operating instructions as well as all other product-related documents on to all owners of the product.
- If you feel that these operating instructions contain errors, inconsistencies, ambiguities or other issues, contact the manufacturer prior to using the product.

These operating instructions are protected by copyright and may only be used as provided for by the corresponding copyright legislation. We reserve the right to modifications.

The manufacturer shall not be liable in any form whatsoever for direct or consequential damage resulting from failure to observe these operating instructions or from failure to comply with directives, regulations and standards and any other statutory requirements applicable at the installation site of the product.

2. Information on safety

2.1 Safety messages and hazard categories

These operating instructions contain safety messages to alert you to potential hazards and risks. In addition to the instructions provided in these operating instructions, you must comply with all directives, standards and safety regulations applicable at the installation site of the product. Verify that you are familiar with all directives, standards and safety regulations and ensure compliance with them prior to using the product.

Safety messages in these operating instructions are highlighted with warning symbols and warning words. Depending on the severity of a hazard, the safety messages are classified according to different hazard categories.



DANGER

DANGER indicates a hazardous situation, which, if not avoided, will result in death or serious injury.

NOTICE

NOTICE indicates a hazardous situation, which, if not avoided, can result in equipment damage.

In addition, the following symbols are used in these operating instructions:



This is the general safety alert symbol. It alerts to injury hazards or equipment damage. Comply with all safety instructions in conjunction with this symbol to help avoid possible death, injury or equipment damage.



This symbol alerts to hazardous electrical voltage. If this symbol is used in a safety message, there is a hazard of electric shock.

2.2 Intended use

This product may only be used to control the temperature in single rooms with an underfloor heating system (heating/cooling).

Any use other than the application explicitly permitted in these operating instructions is not permitted and causes hazards.

Verify that the product is suitable for the application planned by you prior to using the product. In doing so, take into account at least the following:

- All directives, standards and safety regulations applicable at the installation site of the product
- All conditions and data specified for the product
- The conditions of the planned application

In addition, perform a risk assessment in view of the planned application, according to an approved risk assessment method, and implement the appropriate safety measures, based on the results of the risk assessment.

Take into account the consequences of installing or integrating the product into a system or a plant.

When using the product, perform all work and all other activities in conjunction with the product in compliance with the conditions specified in the operating instructions and on the nameplate, as well as with all directives, standards and safety regulations applicable at the installation site of the product.

2.3 Predictable incorrect application

The product must never be used in the following cases and for the following purposes:

- Hazardous area (EX)
 - If the product is operated in hazardous areas, sparks may cause deflagrations, fires or explosions.
- In conjunction with products which are used for health-saving or life-saving purposes or whose operation may incur hazards to humans, animals or property.

2.4 Qualification of personnel

Only appropriately trained persons who are familiar with and understand the contents of these operating instructions and all other pertinent product documentation are authorized to work on and with this product.

These persons must have sufficient technical training, knowledge and experience and be able to foresee and detect potential hazards that may be caused by using the product. All persons working on and with the product must be fully familiar with all directives, standards and safety regulations that must be observed for performing such work.

2.5 Personal protective equipment

Always wear the required personal protective equipment. When performing work on and with the product, take into account that hazards may be present at the installation site which do not directly result from the product itself.

2.6 Modifications to the product

Only perform work on and with the product which is explicitly described in these operating instructions. Do not make any modifications to the product which are not described in these operating instructions.

3. Transport and storage

The product may be damaged as a result of improper transport or storage.

NOTICE

Improper handling

- Verify compliance with the specified ambient conditions during transport or storage of the product.
- Use the original packaging when transporting the product.
- Store the product in a clean and dry environment.
- Verify that the product is protected against shocks and impact during transport and storage.

Failure to follow these instructions can result in equipment damage.

4. Product description

4.1 Overview of the individual components

Component	Versions	Explanation
Base module Control	EBC	Power supply, including relay pump switching, heating/cooling relay
Timer unit	EET	Time-controlled temperature reduction
Room sensor	ER	Room sensor wired
	ERWL	Room sensor wireless
Connection module (wired)	EAR2	With 2 control circuits/wired
	EAR6	With 6 control circuits/wired
Connection module WL (wireless)	EAR2WL	With 2 control circuits/wireless
	EAR6WL	With 6 control circuits/wireless

4.2 Overview

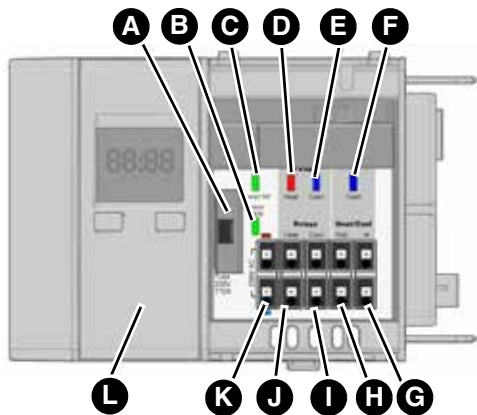

- A. Fuse compartment
- B. Operation mains voltage (LED green)
- C. Operation 5 V (LED green)
- D. Pump Heating (LED red)
- E. Pump Cooling (LED blue)
- F. Cooling (LED blue)
- G. Input switchover Heating/Cooling
- H. Cascading output Heating/Cooling
- I. Relay contact pump Cooling
- J. Relay contact pump Heating
- K. Mains voltage 230 V AC
- L. Timer unit (optional)

4.3 Dimensions

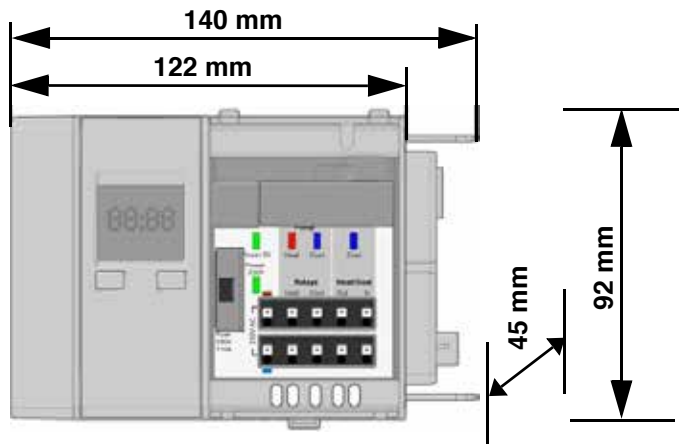

4.4 Application example(s)

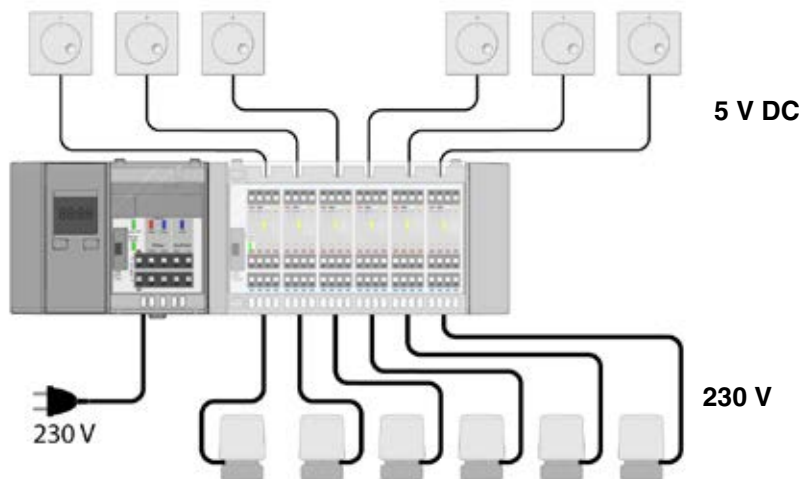

Fig. 1: Base module Control, connection module, timer unit, wired room sensors and actuators, recommended cable for connection of the room sensors J-Y (ST) Y 2 x 2 x 0.6 mm

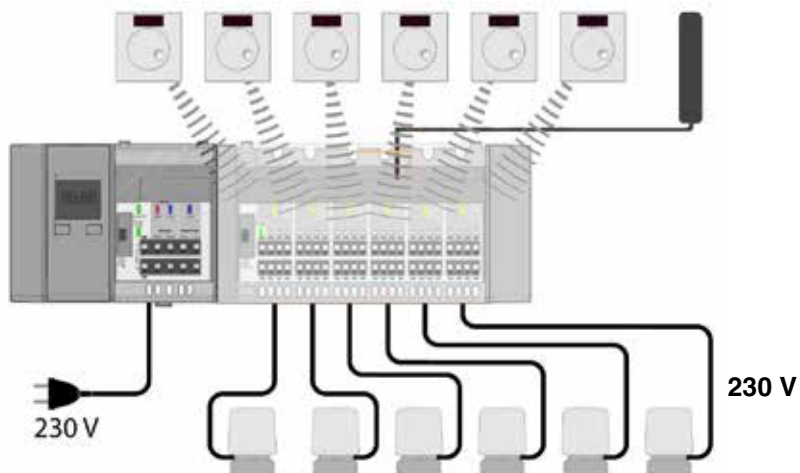

Fig. 2: Base module Control, connection module WL, timer unit, room sensor WL, external antenna and actuators

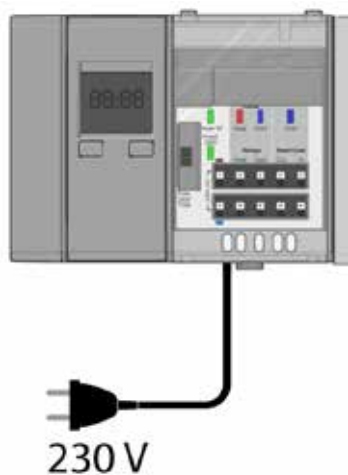

Fig. 3: Base module Control with timer unit

4.5 Function

The room temperature control sets the temperature in individual rooms with floor heating systems (heating/cooling). The base module Control is the central component. Connection modules can be connected to the product.

The product supplies the connection modules with 5 V DC and the thermal actuators with 230 V AC via the connection modules.

The control circuit pumps can be controlled via the product. In conjunction with room sensors WL, only the thermal actuators are supplied with 230 V AC.

4.6 Approvals, conformities, certifications

The product complies with:

- EMC Directive (2014/30/EU)
- Low Voltage Directive (2014/35/EU)
- Radio Equipment Directive, RED (2014/53/EU)
- RoHS Directive (2011/65/EU)

The declaration of conformity can be accessed (downloaded) at www.bekotec-therm.co.uk

4.7 Technical specifications

Parameter	Value
General specifications	
Dimensions housing (W x H x D)	122 x 92 x 45 mm
Weight	215 g
Housing material	PC/ABS
Colour	Light grey, similar to RAL 7047
Ambient conditions	
Ambient temperature for operation	-20 ... 60 °C
Ambient temperature for storage	-20 ... 60 °C
Max. humidity	non-condensing
Supply voltage	
Nominal voltage	AC 230 V, 50 Hz to 60 Hz
Nominal power (base module Control only)	1 VA
Mains fuse	T 10 A
Relay load	Max. 230 V, max. 2 A, power factor > 0.6
Permissible cable type	H03 VV-H2-F 2 x 0.75 mm ²
The following components may be connected to one product	
Connection module EAR6 (6 x)	Max. 3
Connection module EAR2 (2 x)	Max. 9
Total number of control circuits	18 room sensors max.
Total number of thermal actuators	Max. 72
Electrical data	
Protection class (EN 60730-1)	II
Protection type (EN 60529)	IP 20

4.8 Information on the product group as per EN 60730-2017-05

- The product group is an electronic control type C as per EN 60730-1.
- The product group is suitable for continuous operation.
- The type of disconnection of the actuators and pumps is micro disconnection.
- The PTI value of the insulation (PCBs) is 175.
- The product group corresponds to installation category 3.
- The product group corresponds to overvoltage category 2.
- The limit value for low voltage (SELV circuit) is 5 V DC.
- The maximum permissible click rate is 1/minute.
- The test voltage for the EMC noise immunity tests is $\pm 1\text{KV}$ ($\pm 2\text{KV}$).

4.9 Information on the product group as per EN 15500:2008-12

- Type: Fixed point function
- Zone type: Constant conditions
- Application groups: Individual zone control equipment
- Output types: On/off actuators
- Sensor type: NTC $\pm 5\%$.
- Certified value of control accuracy: 0.6 K (0.5 K).

5. Mounting

5.1 Installation site

The product must be mounted in the vicinity of the heating circuit manifold.

5.2 Mounting the product

⇒ Verify that the product is disconnected from mains.

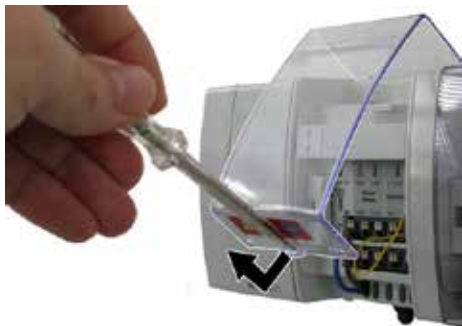

1. Open the cover using a screwdriver.



2. Pull off the end cover.
3. Connect the connection module(s)/connection module(s) WL to the product.



4. Push down the two catches.



5. Fit the end cover onto the last connection module/connection module WL.

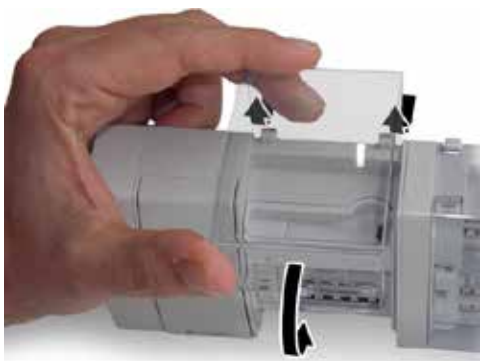

6. Refit the cover and close it.

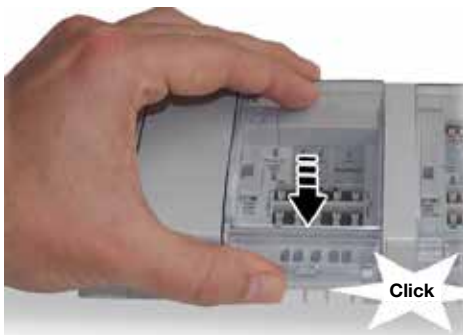

5.3 Electrical connection



DANGER

ELECTRIC SHOCK

- Verify that the degree of protection against electric shock (protection class, double insulation) is not reduced by the type of electrical installation.
- Failure to follow these instructions will result in death or serious injury.**



DANGER

ELECTRIC SHOCK CAUSED BY LIVE PARTS

- Disconnect the mains voltage supply before performing the work and ensure that it cannot be switched on.
 - Verify that no hazards can be caused by electrically conductive objects or media.
- Failure to follow these instructions will result in death or serious injury.**

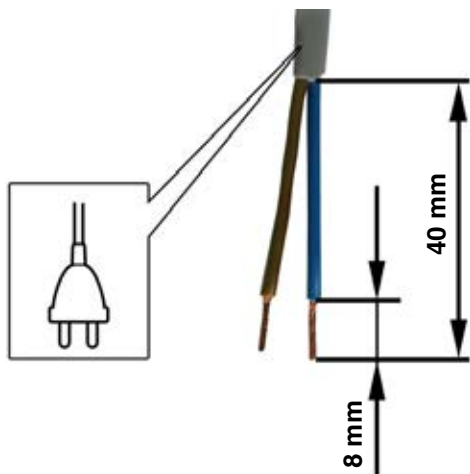

- ⇒ Verify that a connection concept has been created.
 - Verify that the correct assignment of the switching channels for the timer unit has been considered.
- ⇒ Verify that all cables are disconnected from power.

1. Strip the cables as shown.

Permissible cable type:
H03 VV-H2-F 2 x 0.75 mm²

5.3.3 Connection diagram in the case of multiple products (cascading)

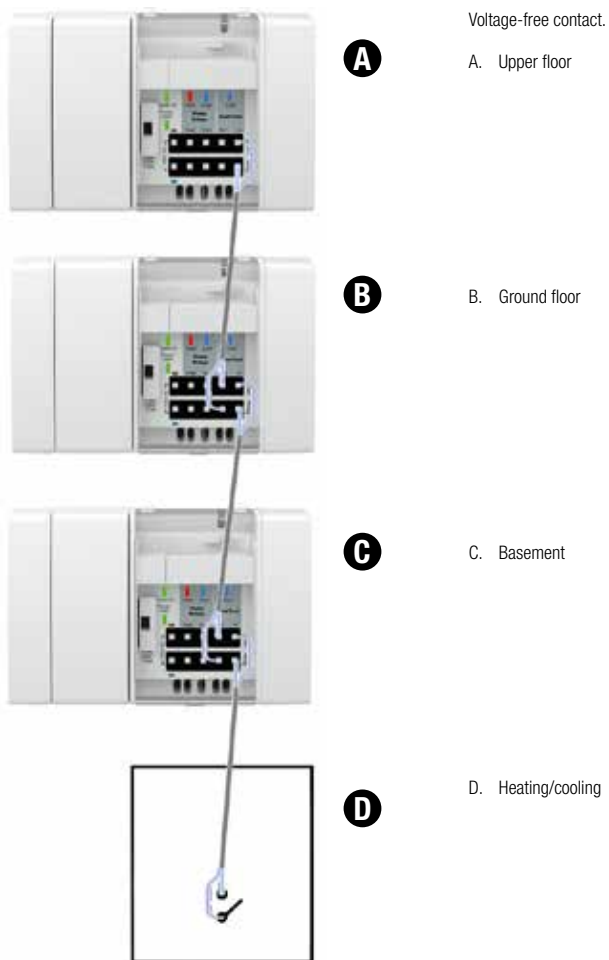

5.3.4 Fitting the cable clamp

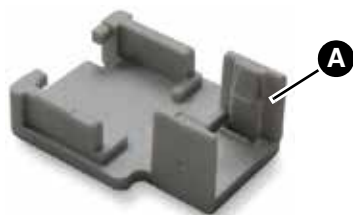

1. Fix the cable at the rear of the connection module /connection module WL using the cable clamp.
 - If room sensors with a wired connection are used, first make the electrical connection of the room sensors and then fit the cable clamp.

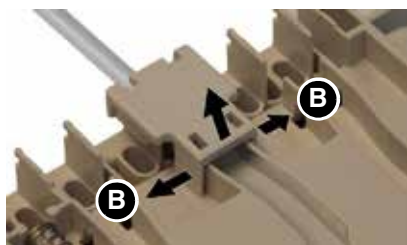
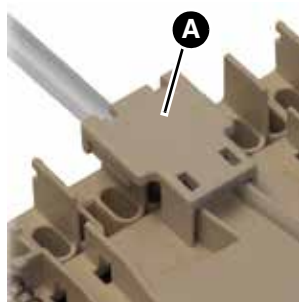

2. Repeat this procedure for all other cables.
3. To detach the cable clamp, lift up the two tabs (B) on the outside and remove the cable clamp.

5.3.5 Mounting modules on a DIN rail

- ⇒ Verify that all modules (base module Control and connection module/connection module WL) are plugged together and firmly locked.
- ⇒ Verify that all cables are connected.



1. Fit the modules into the DIN rail with the upper hooks.

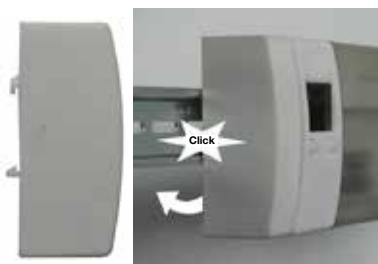

2. Push the lower end of the modules towards the DIN rail until they snap in with a click.

5.4 Removing modules from a DIN rail



1. Slightly lift the modules.



2. Tilt the top of the modules away from the DIN rail.



3. Remove the connected modules towards the bottom.

6. Operation

6.1 Overview of the LED signals

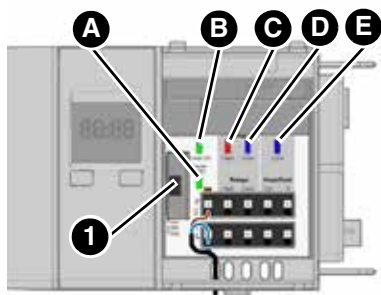

	Indication	State	Explanation
A.	Operation mains voltage (LED green)	Light on	When 230 V AC mains voltage is applied.
		Light off	In the case of power outage. If the fuse (1) trips.
B.	Operation 5 V (LED green)	Light on	If 5 V supply is applied.
		Light off	In the case of power outage. If the fuse (1) trips. If the 5 V supply fails.
C.	Pump Heating (LED red)	Light on	If at least one room sensor is requesting heating energy.
		Light off	If no room sensor is requesting heating energy.
D.	Pump Cooling (LED blue)	Light on	If the controller is set to "Cooling" and if at least one room sensor is requesting "Cooling".
		Light off	If no room sensor is requesting cooling.
E.	Cooling (LED blue)	Light on	If the controller is set to "Cooling".
		Light off	If the controller is set to "Heating".

7. Maintenance

The product is maintenance-free.

8. Troubleshooting

System impairments that cannot be eliminated with the measures described in this section may only be addressed by the manufacturer.

Problem	Possible reason	Repair
LED operation mains voltage not lit (green LED)	No mains voltage	Check the supply voltage
	Fuse defective	Check the fuse
LED 5 V operation not lit (green LED)	No mains voltage	Check the supply voltage
	Fuse defective	Check the fuse
	Power supply unit defective	Contact your specialised company
Other malfunctions	–	Contact your specialised company

8.1 Replacing the mains fuse

⇒ Verify that the mains voltage is disconnected and cannot be switched on.



1. Open the cover using a screwdriver.

Example: Replacing the fuse in the base module Control.



2. Remove the fuse holder.



3. Replace the defective fuse with a G fuse insert 5 x 20 mm, see Table 1.



4. Insert the fuse holder into the fuse compartment.
5. Close the cover.

Art.-No.	Product	Fuse type
BTEBC	Base module Control	T 10 A
BTEAR2, BTEAR2WL	Connection module for 2 room sensors	T 1 A
BTEAR6, BTEAR6WL	Connection module for 6 room sensors	T 3.15 A

Table 1: Overview fuse types

9. Decommissioning, disposal

Dispose of the product in compliance with all applicable directives, standards and safety regulations. Electronic components must not be disposed of together with the normal household waste.



1. Disconnect the product from mains.
2. Dismount the product (see chapter "Mounting", reverse sequence of steps).
3. Dispose of the product.

10. Warranty

See our terms and conditions or your purchase contract for information on warranty.

11. Spare parts and accessories

NOTICE



UNSUITABLE PARTS

- Only use genuine spare parts and accessories provided by the manufacturer.
Failure to follow these instructions can result in equipment damage.

Product

Product designation	Art.-No.	Figure
Base module Control "BTEBC"	BTEBC	

Spare parts and accessories

Product designation	Art.-No.	Figure
Timer unit	BTEET	
Schlüter®-BEKOTEC-Z spare antenna	250002	
Connection cable for room sensors (J-Y (St) Y 2 x 2 x 0.6 mm)	BTZK4A100M	

Schlüter-Systems KG · Schmölestraße 7 · D-58640 Iserlohn

Tel.: +49 2371 971-1261 · Fax: +49 2371 971-1112 · info@schlueter.de · schlueter-systems.com

Schlüter-Systems Ltd · Units 3-6 Bardon 22 Industrial Estate · Bardon Hill · Coalville · Leicestershire · LE67 1TE

Tel.: +44 1530 813396 · Fax: +44 1530 813376 · sales@schluter.co.uk · schluter.co.uk