

Schlüter®-BEKOTEC-THERM

Single Room Underfloor Heating Kits

Installation Guide

Installation Helpline
01530 813 396



Substrate Preparation

The substrate must be dry, clean, load bearing, even and rigid. There must be no humps, hollows or high spots. If necessary, use an appropriate levelling compound. If the Schlüter®-BEKOTEC-THERM EN 23 F Kits are being used with insulation panels, it is important the insulation panels are fully supported and have taped staggered joints.

Building Conditions

Schlüter®-BEKOTEC-THERM Kits must only be installed in fully watertight buildings. Windows must be installed and closed, as must any other openings. Interior walls must be finished. There must be no risk of frost compromising the installation. For floor substrates that are in direct contact with the soil a suitable damp proof membrane must be installed.

Mixing Station

With either Kit 1 the single room pack mixing station UFHC980357 can be positioned wherever convenient. However, with both Kits 2 & 3 it is critical that the mixing station is positioned so that the two spirals/snakes of heating pipe are exactly the same length.

The single room pack mixing station UFHC980357 must be installed as per the instructions in the box it is supplied in.

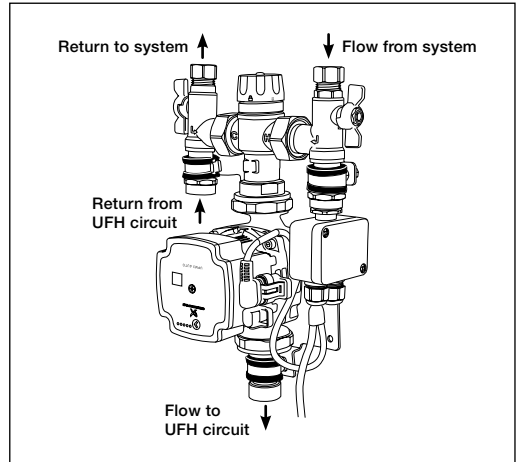

Installing the Thermostat

Whichever thermostat you choose to use full installation and set-up instructions are included in the box it is supplied in.

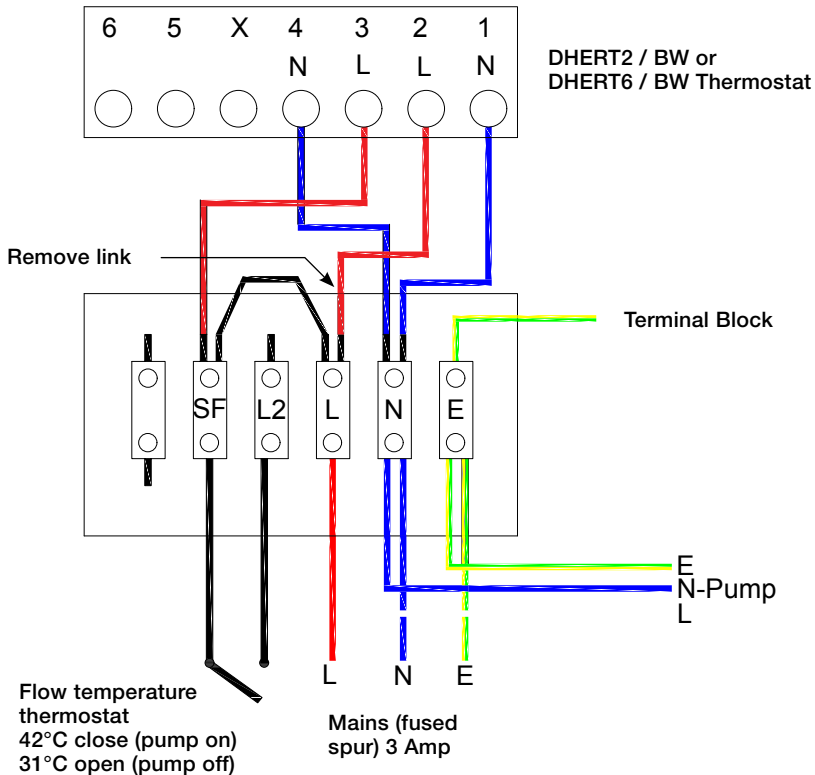

Schlüter®-BEKOTEC-THERM EN 12 FK Kits

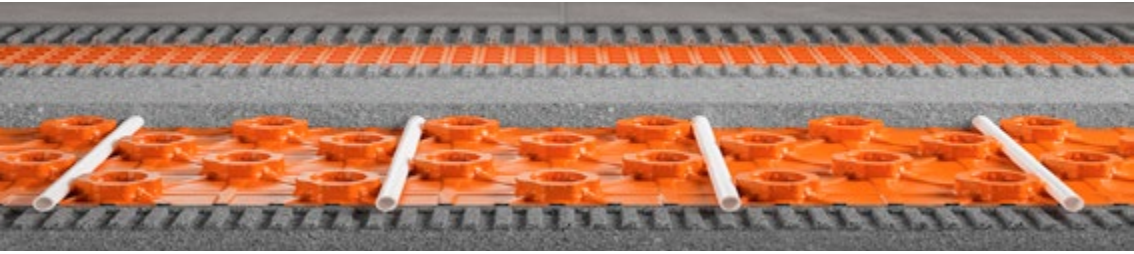

Screed Thickness

The minimum depth of the screed above the studs of the panels is 8mm and the maximum depth is 15mm.

Installing the Modular Studded Screed Panels

Before installing the studded panels, the BRS808KSF self-adhesive edge insulation strip must be secured around the perimeter with the foam appearing 'as a skirting board' on the wall.

The studded panels Schlüter-BEKOTEC-EN12FK must then be adhered to the substrate with a C2 or C2F classification cementitious tile adhesive using a 6 x 6mm notched trowel.

The panels must be connected by overlapping a row of studs. Those around the perimeter must be carefully cut to ensure the panels fit snugly wall to wall.

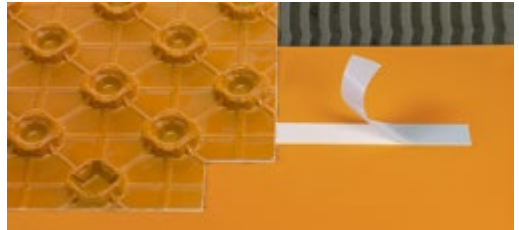

The levelling panel Schlüter-BEKOTEC-EN12FGK must be used in doorways. It must be fitted underneath the adjacent studded panel(s) and bonded to the substrate with a C2 or C2F classification cementitious tile adhesive using a 6 x 6 mm notched trowel. It is adhered to the underside of the studded panel(s) using the BTZDK66 double-sided tape.

Installing the Heating Pipe - Kit 1

The 10 mm diameter heating pipe BTZR10RT70 must be clipped into the studded panels in a spiral/snail configuration, as below, ensuring the pipe spacing is 150 mm.

The heating pipe must be installed at least 50mm from walls and other uprights and at least 200mm from chimneys, open fireplaces and ducts. It must not be positioned below kitchen units and other types of fixed floor furniture. These are classed as 'dead' zones.

Having allowed enough heating pipe to facilitate connection to the mixing station (typically no more than 500mm) any surplus heating pipe should be cut off and discarded.

The self-adhesive pipe clamping strip BTZRKL1012 must be used to secure the heating pipe on to the levelling panel Schluter-BEKOTEC-EN12FGK used in doorways.

The angle clips BTZW1014 must be used to provide the heating pipe with a 90° angle as the flow and return connect to the mixing station

The connector fittings BTZ2AN14 and the compression fitting/clamp connections BTZ2KV10 must be used to connect the heating pipe flow and return to the mixing station (see drawing 1).

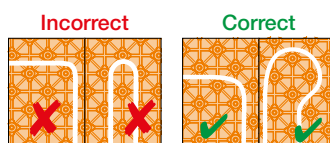
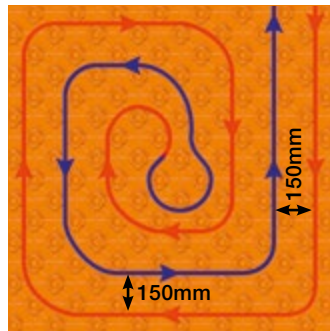

Schlüter®-BEKOTEC-THERM EN 12 FK Kits

Installing the Heating Pipe - Kit 2

Having divided the room so that the area to be heated is split into two equal parts, the 10mm diameter heating pipe BTHR10RT70 must be cut into two 35m lengths. Each 35m length is clipped into the studded panels in the same spiral/snail configuration, as below, ensuring the pipe spacing is 150mm.

The heating pipes must be installed at least 50mm from walls and other uprights and at least 200mm from chimneys, open fireplaces and ducts. They must not be positioned below kitchen units and other types of fixed floor furniture. These are classed as 'dead' zones.

Check the length of heating pipe used in each part is equal and if it is, having allowed enough heating pipe to facilitate connection to the mixing station (typically no more than 500mm), any surplus heating pipe should be cut off and discarded. If the lengths are not equal it is important that the heating pipe is re-laid to obtain two equal lengths.

The self-adhesive pipe clamping strip BTZRKL1012 must be used to secure the heating pipe on to the levelling panel Schluter-BEKOTEC-EN12FGK used in doorways.

The angle clips BTZW1014 must be used to provide the heating pipe with a 90° angle to the flow and return connect to the mixing station.

The connector fittings BTZ2AN14, the compression fitting/clamp connections BTZ2KV10 and the twin connectors BTZ2DA must be used to connect the flow and return of both heating pipes to the mixing station (see drawing 3).

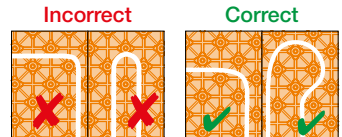
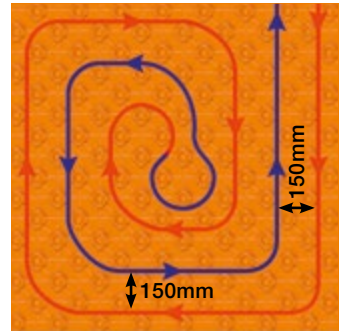
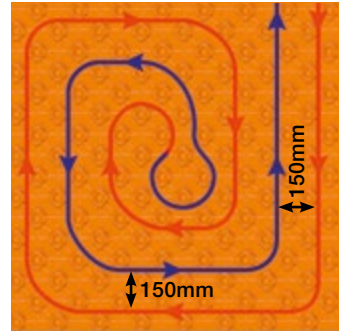

Installing the Heating Pipe - Kit 3

Having divided the room so that the area to be heated is split into two equal parts, the 10mm diameter heating pipe BTHR10RT120 must be clipped into the studded panels in the first part of the room. The heating pipe must then be cut (leaving a few metres extra as 'insurance'), and the remaining pipe used to repeat the process in the second part of the room. It is critical both parts of the room have the same length of heating pipe installed and that it is laid in a spiral/snail configuration, as below, with a pipe spacing of 150mm.

The heating pipes must be installed at least 50mm from walls and other uprights and at least 200mm from chimneys, open fireplaces and ducts. They must not be positioned below kitchen units and other types of fixed floor furniture. These are classed as 'dead' zones.

Check the length of heating pipe used in each part is equal and if it is, having allowed enough heating pipe to facilitate connection to the mixing station (typically no more than 500mm), any surplus heating pipe should be cut off and discarded. If the lengths are not equal it is important that the heating pipe is re-laid to obtain two equal lengths.

The self-adhesive pipe clamping strip BTZRKL1012 must be used to secure the heating pipe on to the levelling panel Schluter-BEKOTEC-EN12FGK used in doorways.

The angle clips BTZW1014 must be used to provide the heating pipe with a 90° angle as the flow and return connect to the mixing station.

The connector fittings BTZ2AN14, the compression fitting/clamp connections BTZ2KV10 and the twin connectors BTZ2DA must be used to connect the flow and return of both heating pipes to the mixing station (see drawing 3).

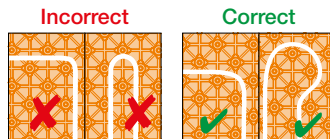
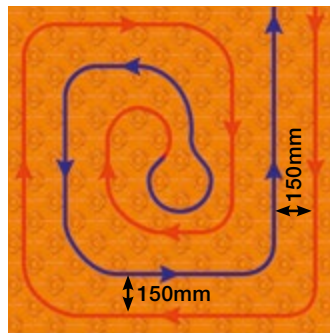
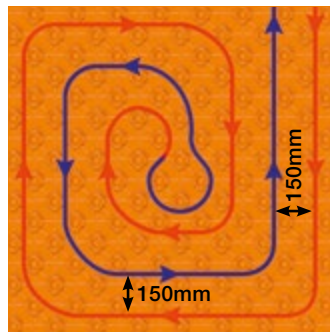

Schlüter®-BEKOTEC-THERM EN 23 F Kits



Screed Thickness

The minimum depth of the screed above the studs of the panels is 8mm and the maximum depth is 25mm.

Installing the Modular Studded Screed Panels

Before installing the studded panels, the BRS808KSF self-adhesive edge insulation strip must be secured around the perimeter with the foam appearing 'as a skirting board' on the wall.

The studded panels Schlüter-BEKOTEC-EN23F must then be adhered to the substrate using the BTZDK66 double-sided tape. The tape must be applied to the underside of the panel so as to form a cross, running from corner to corner.

The panels must be connected by overlapping a row of studs. Those around the perimeter must be carefully cut to ensure the panels fit snugly wall to wall.



The levelling panel Schlüter-BEKOTEC-ENFG must be used in doorways. It must be fitted underneath the adjacent studded panel(s) and adhered to the substrate and the underside of the studded panel(s) using the BTZDK66 double-sided tape.

Installing the Heating Pipe - Kit 1

The 14mm diameter heating pipe BTHR14RT70 must be clipped into the studded panels in a spiral/snail configuration, as below, ensuring the pipe spacing is 150mm.

The heating pipe must be installed at least 50mm from walls and other uprights and at least 200mm from chimneys, open fireplaces and ducts. It must not be positioned below kitchen units and other types of fixed floor furniture. These are classed as 'dead' zones.

Having allowed enough heating pipe to facilitate connection to the mixing station (typically no more than 500mm) any surplus heating pipe should be cut off and discarded.

The self-adhesive pipe clamping strip BTZRKL must be used to secure the heating pipe on to the levelling panel Schluter-BEKOTEC-ENFG used in doorways.

The angle clips BTZW1418 must be used to provide the heating pipe with a 90° angle as the flow and return connect to the mixing station

The connector fittings BTZ2AN14 must be used to connect the heating pipe flow and return to the mixing station (see drawing 2).

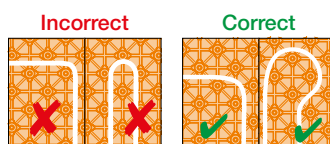
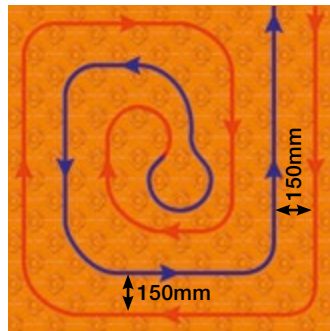

Schlüter®-BEKOTEC-THERM EN 23 F Kits

Installing the Heating Pipe - Kit 2

Having divided the room so that the area to be heated is split into two equal parts, the 14mm diameter heating pipe BTHR14RT120 must be clipped into the studded panels in the first part of the room. The heating pipe must then be cut (leaving a few metres extra as 'insurance'), and the remaining pipe used to repeat the process in the second part of the room. It is critical both parts of the room have the same length of heating pipe installed and that it is laid in a spiral/snail configuration, as below, with a pipe spacing of 150mm.

The heating pipes must be installed at least 50mm from walls and other uprights and at least 200mm from chimneys, open fireplaces and ducts. They must not be positioned below kitchen units and other types of fixed floor furniture. These are classed as 'dead' zones.

Check the length of heating pipe used in each part is equal and if it is, having allowed enough heating pipe to facilitate connection to the mixing station (typically no more than 500mm), any surplus heating pipe should be cut off and discarded. If the lengths are not equal it is important that the heating pipe is re-laid to obtain two equal lengths.

The self-adhesive pipe clamping strip BTZRKL must be used to secure the heating pipe on to the levelling panel Schlüter-BEKOTEC-ENFG used in doorways.

The angle clips BTZW1418 must be used to provide the heating pipe with a 90° angle as the flow and return connect to the mixing station.

The connector fittings BTZ2AN14, the compression fitting/clamp connections BTZ2KV14 and the twin connectors BTZ2DA must be used to connect the flow and return of both heating pipes to the mixing station (see drawing 3).

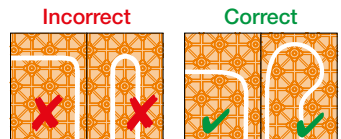
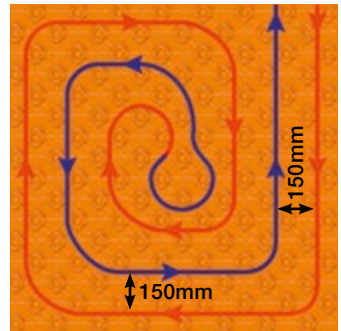
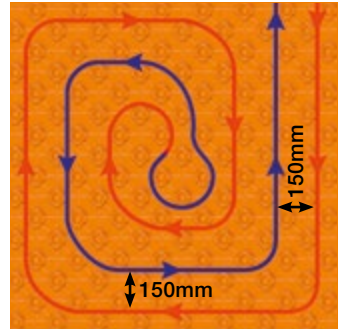

Installing the Heating Pipe - Kit 3

Having divided the room so that the area to be heated is split into two equal parts, each of the 14mm diameter heating pipes BTHR14RT70 must be clipped into the studted panels in the first part of the room. The heating pipe must then be cut (leaving a few metres extra as 'insurance'), and the remaining pipe used to repeat the process in the second part of the room. It is critical both parts of the room have the same length of heating pipe installed and that it is laid in a spiral/snail configuration, as below, with a pipe spacing of 225mm.

The heating pipes must be installed at least 50mm from walls and other uprights and at least 200mm from chimneys, open fireplaces and ducts. They must not be positioned below kitchen units and other types of fixed floor furniture. These are classed as 'dead' zones.

Check the length of heating pipe used in each part is equal and if it is, having allowed enough heating pipe to facilitate connection to the mixing station (typically no more than 500mm), any surplus heating pipe should be cut off and discarded. If the lengths are not equal it is important that the heating pipe is re-laid to obtain two equal lengths.

The self-adhesive pipe clamping strip BTZRKL must be used to secure the heating pipe on to the levelling panel Schluter-BEKOTEC-ENFG used in doorways.

The angle clips BTZW1418 must be used to provide the heating pipe with a 90° angle as the flow and return connect to the mixing station.

The connector fittings BTZ2AN14, the compression fitting/clamp connections BTZ2KV14 and the twin connectors BTZ2DA must be used to connect the flow and return of both heating pipes to the mixing station (see drawing 3).

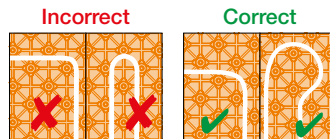
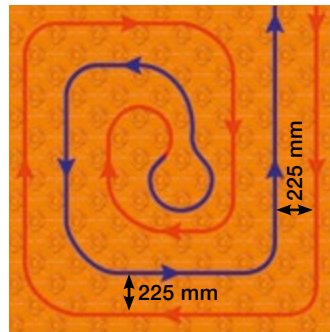
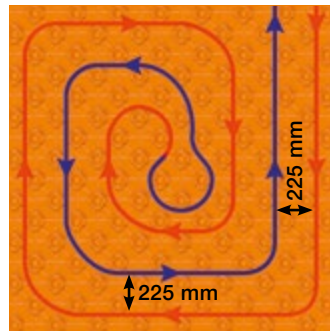

Drawing 1



Drawing 2



Drawing 3

BTZ2AN14

Remove Nut,
Olive & Insert

BTZ2DA

BTZ2KV14 or
BTZ2KV10

BTZW1014 or BTZW1418

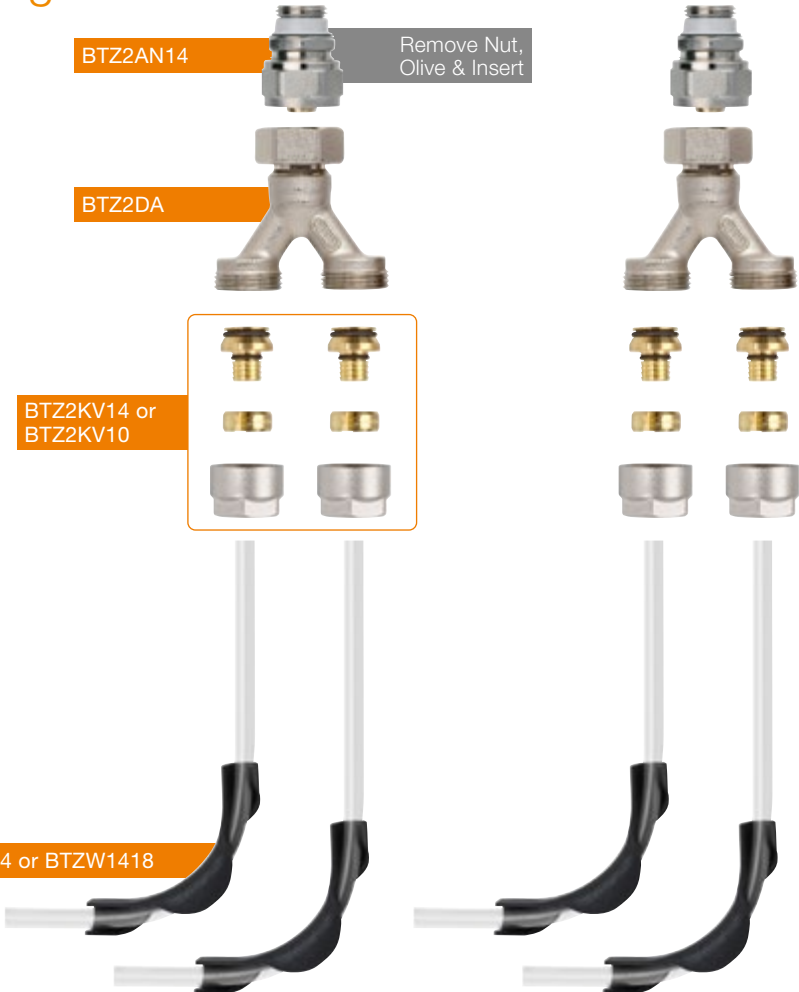

Notes

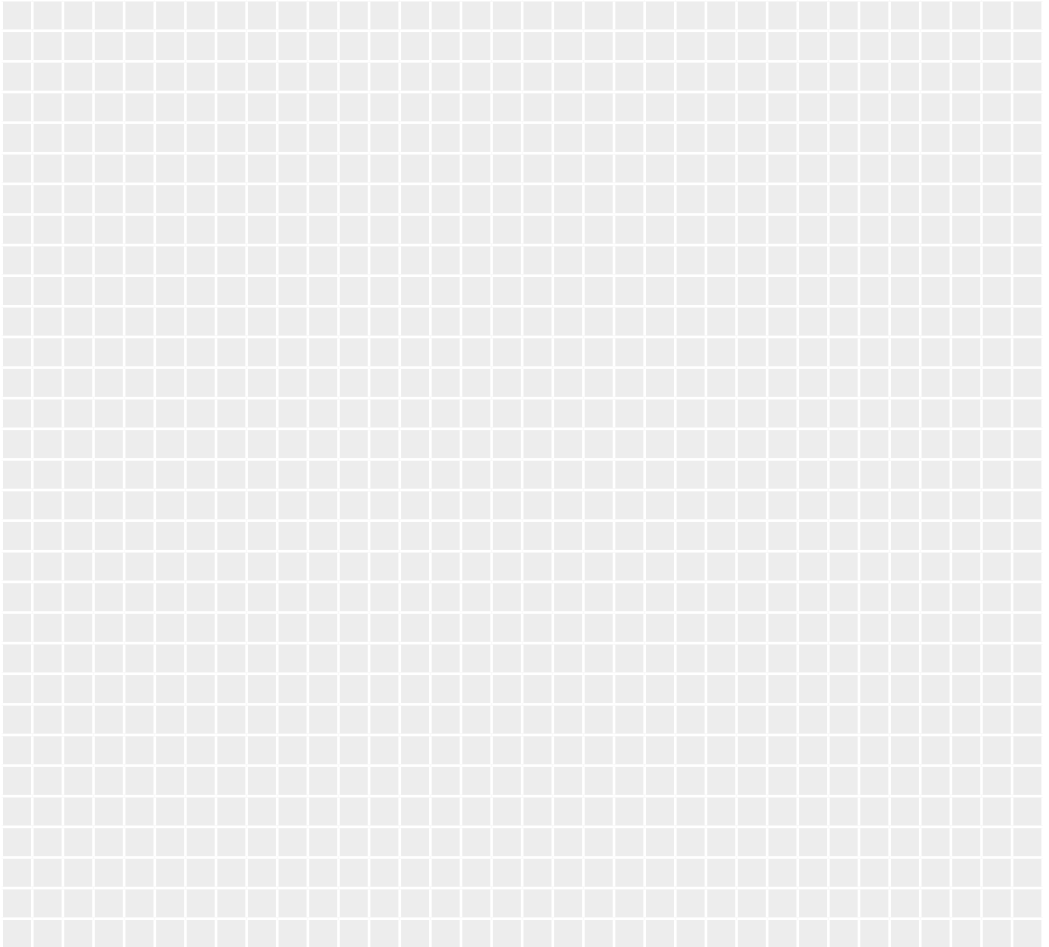



Information.

If you have any questions about the installation process or any of our products please contact Schlüter Technical Support on technical@schluter.co.uk or +44 (0) 1530 813396.

Subject to the Standard Terms and Conditions of Sale of Schlüter-Systems Ltd.

All information contained within this document is considered to be true and correct at the date of publication; changes to regulations, standards etc. after the date of publication may impact on the accuracy of the information.

For reasons of printing, colours shown in this installation guide may differ from actual product colours.

