

Durability meets design

Stainless steel products by Schlüter®-Systems



© Atlas Concorde



PROFILE OF INNOVATION



High quality stainless steel Schlüter®-PROFILES

Stainless steel is enjoying increasing popularity and necessity in architectural projects. In response to this rising demand, Schlüter-Systems now offers a broad assortment of profiles made of this material.

All stainless steel products available are manufactured in material quality V2A (material no. 1.4301 = AISI 304). Many of the profiles are also available in material quality V4A (material no. 1.4404 = AISI 316L). Due to their enhanced resistance to chemicals and corrosion, these are suitable for use in areas with special stresses such as hygiene environments, kitchens, swimming pools (fresh water) or industrial facilities.

In addition to the classic finishing profiles Schlüter-SCHIENE, Schlüter-RONDEC, or Schlüter-QUADEC, we also offer edge protection profiles (Schlüter-ECK), stair-nosing profiles (Schlüter-TREP-E), movement joint profiles (Schlüter-DILEX-EKSN, -EKSB and -EKSBT) as well as cove-shaped profiles (Schlüter-DILEX-EHK and -HKS) in stainless steel quality V4A.

Even stainless steel of quality 1.4404 is not resistant to all chemical stresses, and may be affected, e.g., by hydrochloric and hydrofluoric acid or certain chloride and brine concentrations. In certain cases, this also applies to seawater pools. Special anticipated stresses and cleaning requirements should therefore be verified in advance.





What is stainless steel?

"Stainless steel" is a generic term that describes over 160 types of alloy steels, which are suitable for a wide range of applications with their different compositions.

Stainless steel is not necessarily rust free and needs to be maintained. When chromium is added to the alloy, it forms a dense, protective passivation layer on the steel surface in a thickness of about 1000th of a millimetre. Even though this layer is very thin, it is capable of consistently renewing itself after mechanical damage, which means that this steel will not rust during normal use.

This presumes that the protective layer will not be damaged permanently (e.g. by external corrosion or certain chemicals such

as hydrochloric acid). Such damage can occur in areas with chemical stresses (such as outdoor areas near the sea, or with high industrial air pollution levels), in the food industry, or in swimming pools. In those applications, the use of V4A steel (material no. 1.4404 = AISI 316L) is recommended instead of conventional V2A stainless steel (material no. 1.4301 = AISI 304), since this material has better corrosion resistance for those special requirements.

The Technical Sales department and the sales representatives of Schlüter-Systems are able to provide expert support for specifiers and installers if there are uncertainties about the correct material choice.



i

The official designation for material no. 1.4301 according to DIN EN 10088 is as follows: Abbreviated name X5CrNi18-10. The official designation for material no. 1.4404 according to DIN EN 10088 is as follows: Abbreviated name X2CrNiMo17-12-2.



Maintenance recommendations for stainless steel products





Stainless steel surfaces exposed to the environment or aggressive substances should be cleaned periodically using a mild household cleaner. Regular cleaning maintains the neat appearance of stainless steel and reduces the risk of corrosion. All cleaning agents must be free of hydrochloric and hydrofluoric acid. Avoid contact with other metals, such as regular steel, to prevent corrosion. This also includes installation tools such as trowels or steel wool, e.g. for the removal of mortar residue.

Do not use abrasive cleaning agents on the sensitive surfaces. The stainless steel cleaning polish Schlüter-CLEAN-CP may be used if necessary.

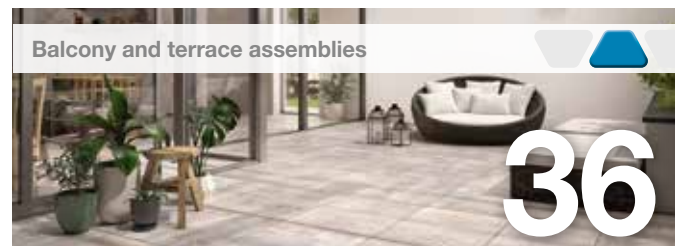

Overview of our stainless steel products



Profiles that are also available in lengths of 3 metres are marked with a  symbol.
Profiles with special radius perforation are labelled with a  symbol.

Finishing profiles for floor coverings

Finishing profiles such as the original Schlüter-SCHIENE are installed at the perimeter of tiled coverings and protect the outside edges of ceramic tile and natural stone coverings from mechanical impact. Schlüter-RENO profiles create a seamless transition to adjoining floor coverings. All our finishing profiles for floor areas protect and enhance the floor covering.





Schlüter®-SCHIENE-E / -ES

Schlüter-SCHIENE-E and -ES are special stainless steel profiles for finishing the outside edges of tile coverings, but are also very well suited for use with other covering materials and applications. SCHIENE-ES and -ES-EB feature a joint spacer.

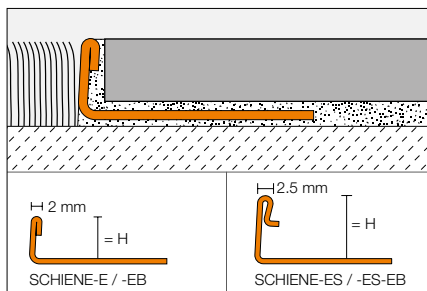

Schlüter®-SCHIENE-E / -ES							
stainless steel V2A/V4A							
H = mm	Schlüter®-SCHIENE-E		Schlüter®-SCHIENE-EB brushed	Schlüter®-SCHIENE-E V4A	Schlüter®-SCHIENE-ES with joint spacer		Schlüter®-SCHIENE-ES-EB brushed with joint spacer
	L = 2.50 m	L = 1.00 m	L = 2.50 m	L = 2.50 m	L = 2.50 m	L = 1.00 m	L = 2.50 m
2	•	—	—	—	—	—	—
3	•	—	—	—	—	—	—
4.5	•	—	—	•	—	—	—
6	• ③	•	• ③	•	—	—	—
7	•	—	—	—	—	—	—
8	• ③	•	• ③	•	• ③	•	• ③
9	•	—	—	—	—	—	—
10	• ③	•	• ③	•	• ③	•	• ③
11	• ③	•	• ③	•	• ③	•	• ③
12.5	• ③	•	• ③	•	• ③	•	• ③
14	•	—	—	•	—	—	—
15	•	—	—	•	—	—	—
16	•	—	—	•	—	—	—
17.5	•	—	—	•	—	—	—
20	•	—	—	•	—	—	—
22.5	•	—	—	•	—	—	—
25	•	—	—	•	—	—	—
30	•	—	—	•	—	—	—

Schlüter®-RENO-TK

Schlüter-RENO-TK is a profile that provides a smooth transition between tiled surfaces and lower adjacent floor coverings, such as carpet or other materials. It effectively protects the edges of adjoining coverings from damage.

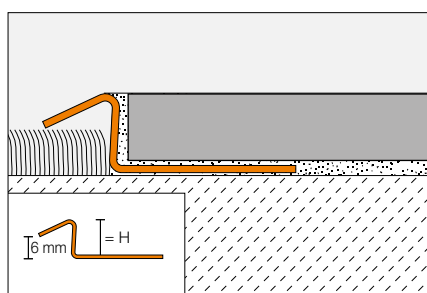

Schlüter®-RENO-ETK / -EBTK				
stainless steel V2A				
H = mm	Schlüter®-RENO-ETK		Schlüter®-RENO-EBTK brushed	
	L = 2.50 m	L = 1.00 m	L = 2.50 m	L = 1.00 m
8	•	•	•	•
10	•	•	•	•
11	•	•	•	•
12.5	•	•	•	•



Schlüter®-RENO-U

Schlüter-RENO-EU is a stainless steel profile that provides a smooth transition between floor coverings of different heights.

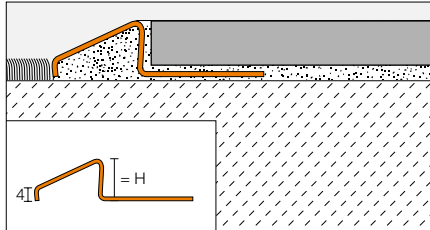

Schlüter®-RENO-EU		
stainless steel V2A		
H = mm	Schlüter®-RENO-EU Schlüter®-RENO-EBU brushed	
	L = 2.50 m	L = 1.00 m
8	•	•
10	•	•
11	•	•
12.5	•	•
15	•	—
17.5	•	—
20	•	—

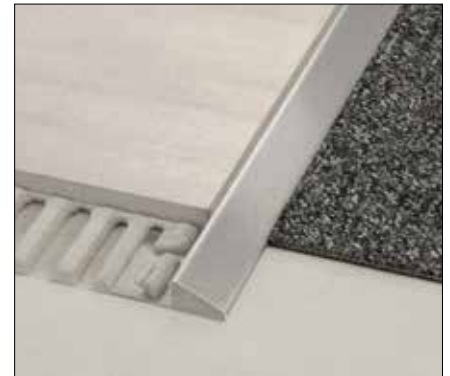

Schlüter®-RENO-T

Schlüter-RENO-T is retrofitted to adjoin different types of floor coverings of the same height.

Schlüter®-RENO-T-E		
stainless steel V2A		
B = mm	Schlüter®-RENO-T-E Schlüter®-RENO-T-EB brushed	
	L = 2.50 m	L = 1.00 m
14	•	•
25	•	•

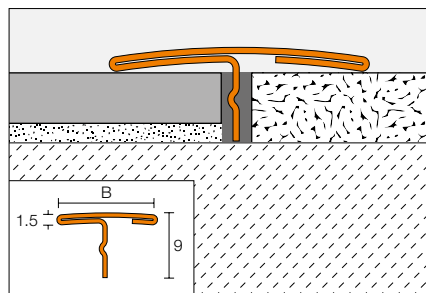

Schlüter®-DECO

Schlüter-DECO is a profile with a wide visible surface for creating decorative joint designs in tiled surfaces.

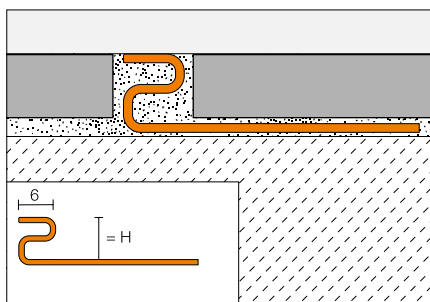

Schlüter®-DECO-E	
stainless steel V2A	
H = mm	Schlüter®-DECO-E
	L = 2.50 m
8	•
9	•
10	•
11	•
12.5	•
14	•
16	•
18.5	•
21	•
25	•
30	•



Schlüter®-DECO-DE

Schlüter-DECO-DE is a high quality finishing profile of stainless steel for 135° degree external wall corners of tile coverings and provides excellent edge protection.

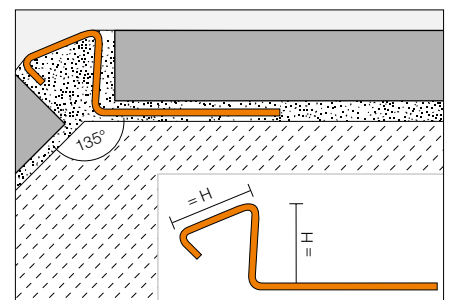

Schlüter®-DECO-DE	
stainless steel V2A	
H = mm	Schlüter®-DECO-DE-E-S 135° Schlüter®-DECO-DE-EB-S brushed
	L = 2.50 m
8	•
10	•
11	•
12.5	•



Wall corners and finishing profiles

The profiles of the Schlüter-QUADEC and Schlüter-RONDEC product ranges create mechanically durable and decorative finishing edges on wall coverings and skirtings made of tiles and natural stone. Schlüter-ECK profiles are particularly suitable for heavily used areas. The Schlüter-DESIGNLINE border profiles or the internal corner profiles Schlüter-ECK-KI and -KHK allow for decorative accents.



Schlüter®-RONDEC-E

Schlüter-RODEC-E is a symmetrically rounded profile designed to protect and decorate external wall corners and other tiled edges, e.g. tiled skirting.

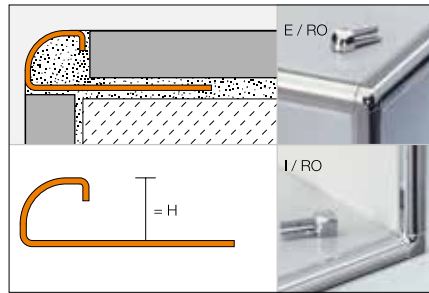

Accessories: Internal and external corners, connector, end caps

Schlüter®-RONDEC-E					TST
stainless steel V2A/V4A					
H = mm	Schlüter®-RONDEC-E		Schlüter®-RONDEC-EB brushed	Schlüter®-RONDEC-EP polished	Schlüter®-RONDEC-E V4A
	L = 2.50 m	L = 1.00 m	L = 2.50 m	L = 2.50 m	L = 2.50 m
4.5	•	—	—	—	—
6	•	•	•	•	•
7	•	—	•	—	—
8	•	•	•	•	•
9	•	—	•	—	—
10	•	•	•	•	•
11	•	—	•	—	—
12.5	•	•	•	•	•
15	•	—	•	•	—

Schlüter®-QUADEC-E

Schlüter-QUADEC is a high quality finishing profile of stainless steel, providing excellent edge protection for the outside corners of tiled walls. The exposed area of the profile forms the right angled external corner of the tile covering.

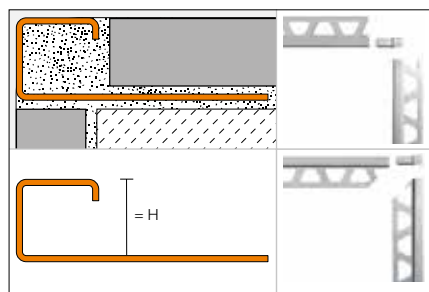

Accessories: Stainless steel corner pieces can be used for internal and external corners, connector and end caps

Schlüter®-QUADEC-E					TST
stainless steel V2A/V4A					
H = mm	Schlüter®-QUADEC-E	Schlüter®-QUADEC-EB brushed	Schlüter®-QUADEC-EP polished	Schlüter®-QUADEC-E V4A	
	L = 2.50 m	L = 2.50 m	L = 2.50 m	L = 2.50 m	
4.5	•	—	—	—	
6	•	•	•	•	
7	•	•	—	—	
8	•	•	•	•	
9	•	•	—	—	
10	•	•	•	•	
11	•	•	—	—	
12.5	•	•	•	•	
14	•	•	—	—	
15	•	•	•	—	

Schlüter®-QUADEC-ES	
stainless steel V2A textured designs ES 1 and ES 2	
H = mm	L = 2.50 m
4.5	—
6	—
7	—
8	•
9	—
10	•
11	•
12.5	•
14	—
15	—



Schlüter®-ECK-E

Schlüter-ECK-E is a stainless steel corner profile that provides stable edge protection for external wall corners of tile coverings. The perforated anchoring legs are fully embedded in the tile adhesive during the installation of the tiles.

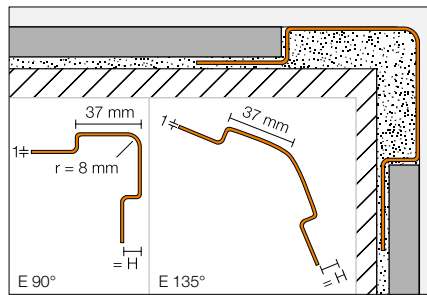

Schlüter®-ECK-E												
stainless steel V2A												
H = mm	Schlüter®-ECK-E				Schlüter®-ECK-E-S 135°		Schlüter®-ECK-EB brushed				Schlüter®-ECK-EB-S brushed, 135°	
	L = 1.50 m	L = 2.00 m	L = 2.50 m	L = 3.00 m	L = 2.50 m	L = 3.00 m	L = 1.50 m	L = 2.00 m	L = 2.50 m	L = 3.00 m	L = 2.50 m	L = 3.00 m
6	•	•	•	•	•	•	•	•	•	•	•	•
8	•	•	•	•	•	•	•	•	•	•	•	•
11	•	•	•	•	•	•	•	•	•	•	•	•

Schlüter®-ECK-E V4A				
stainless steel V4A				
H = mm	L = 1.50	L = 2.00 m	L = 2.50 m	L = 3.00 m
6	—	—	—	—
8	•	•	•	•
11	•	•	•	•

Schlüter®-ECK-K

Schlüter-ECK-K is a stainless steel corner profile that is retrofitted to protect the external corners of tiled walls or other wall coverings.

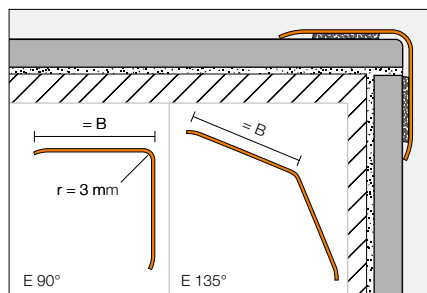

Schlüter®-ECK-K								
stainless steel V2A								
B = mm	Schlüter®-ECK-K-E				Schlüter®-ECK-K-E-S 135°			
	L = 1.50 m	L = 2.00 m	L = 2.50 m	L = 3.00 m	L = 1.50 m	L = 2.00 m	L = 2.50 m	L = 3.00 m
15	•	•	•	•	—	—	—	—
32	•	•	•	•	•	•	•	•
50	•	•	•	•	—	—	—	—

Schlüter®-ECK-K							
stainless steel V2A/V4A							
B = mm	Schlüter®-ECK-K-EB brushed				Schlüter®-ECK-E V4A		
	L = 1.50 m	L = 2.00 m	L = 2.50 m	L = 3.00 m	L = 1.50 m	L = 2.00 m	L = 2.50 m
15	•	•	•	•	—	—	—
32	•	•	•	•	•	•	•
50	•	•	•	•	—	—	—

Schlüter®-ECK-KI

Schlüter-ECK-KI is a stainless steel corner profile that is retrofitted to the internal corners of tiled walls or other wall coverings.

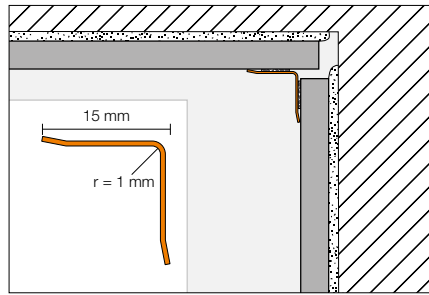

Schlüter®-ECK-KI								
stainless steel V2A								
B = mm	Schlüter®-ECK-KI-E				Schlüter®-ECK-KI-EB brushed			
	L = 1.50 m	L = 2.00 m	L = 2.50 m	L = 3.00 m	L = 1.50 m	L = 2.00 m	L = 2.50 m	L = 3.00 m
15	•	•	•	•	•	•	•	•

Schlüter®-ECK-KHK

Schlüter-ECK-KHK is a cove shaped, stainless steel corner profile that is retrofitted to the internal corners of tiled walls or other wall coverings.

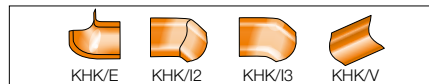
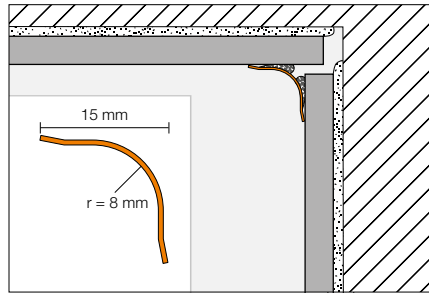

Accessories: Internal and external corners, connector

Schlüter®-ECK-KHK								
stainless steel V2A								
B = mm	Schlüter®-ECK-KHK-E				Schlüter®-ECK-KHK-EB brushed			
	L = 1.50 m	L = 2.00 m	L = 2.50 m	L = 3.00 m	L = 1.50 m	L = 2.00 m	L = 2.50 m	L = 3.00 m
15	•	•	•	•	•	•	•	•

Schlüter®-DESIGNLINE

Schlüter-DESIGNLINE is a border profile for creating decorative designs in wall coverings. These profiles can be combined with the appropriate Schlüter-RONDDEC profiles for external wall corners. The stainless steel profile is also suitable for use in floor coverings.

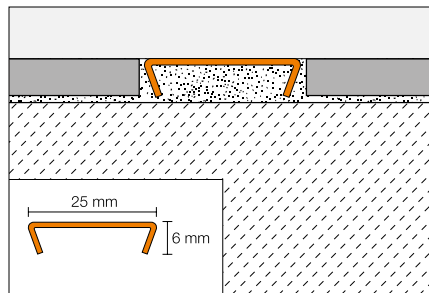

Schlüter®-DESIGNLINE-E			
stainless steel V2A			
L = m	Schlüter®-DESIGNLINE-E	Schlüter®-DESIGNLINE-EB brushed	Schlüter®-DESIGNLINE-ES textured designs ES 1 and ES 2
2.50	•	•	•



Schlüter®-FINEC

Schlüter-FINEC is a high-quality finishing profile made of stainless steel or anodised aluminium for the external edges of tile coverings, mosaics or rendered surfaces. The finishing leg of the profile protects the covering edges from mechanical damage and creates an elegant, slim corner detail.

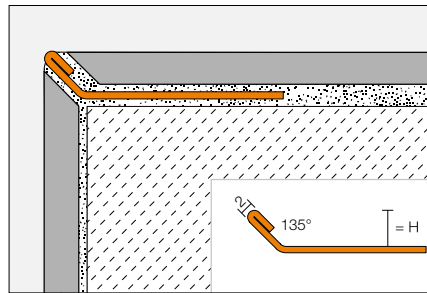

Schlüter®-FINEC-E	
stainless steel V2A	
H = mm	L = 2.50 m
4.5	•
7	•
9	•
11	•
12.5	•



Accessories: Corner set, consisting of three parts

Schlüter®-SCHIENE-STEP-EB

Schlüter-SCHIENE-STEP-EB is a high-quality finishing profile made of brushed stainless steel. Thanks to its variable geometry, this profile can be used for a number of applications such as countertops, stair edges, or to finish "tile on tile" restoration projects.

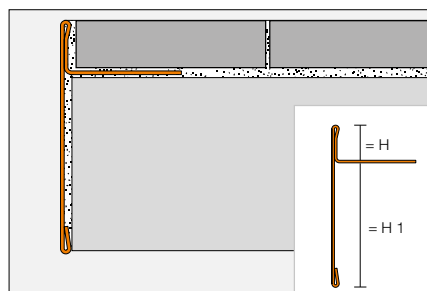

Accessories: Internal and external corners, connector

Schlüter®-SCHIENE-STEP-EB			
stainless steel V2A brushed			
H = mm	H1 = 11 mm L = 2.50 m	H1 = 30 mm L = 2.50 m	H1 = 39 mm L = 2.50 m
6	•	—	•
9	—	•	•
11	—	•	•
12.5	•	•	•



Stairs – safe and stylish

Stair nosings are exposed to heavy mechanical stresses and represent a high accident risk. Schlüter-TREP profiles offer improved safety due to their slip resistant design and high visibility. They protect stair nosings from damage ensuring that the tile covering remains damage free.



Schlüter®-TREP-S

Schlüter-TREP-S-E is a slip resistant stair nosing profile made with a replaceable thermoplastic tread.

Schlüter®-TREP-S-E			
stainless steel support profile narrow (26 mm) V2A, R9			
H = mm	L = 1.00 m	L = 1.50 m	L = 2.50 m
8	•	•	•
10	•	•	•
12.5	•	•	•

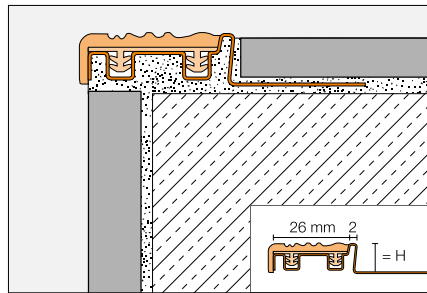

Colours: yellow (CG), grey (G), graphite black (GS), light beige (HB), nut brown (NB)



Accessories: End caps

Schlüter®-TREP-E

Schlüter-TREP-E is a stainless steel stair nosing profile with a special non slip tread.

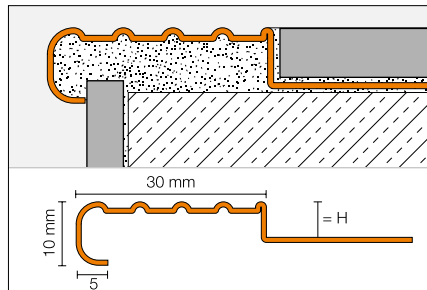

Accessories: End caps

Schlüter®-TREP-E						
stainless steel V2A/V4A. R 10 V 6						
H = mm	Schlüter®-TREP-E			Schlüter®-TREP-E V4A		
	L = 1.00 m	L = 1.50 m	L = 2.50 m	L = 1.00 m	L = 1.50 m	L = 2.50 m
2	•	•	•	—	—	—
3	•	•	•	—	—	—
5	•	•	•	—	—	—
8	•	•	•	•	•	•
11	•	•	•	•	•	•
13	•	•	•	•	•	•
16	•	•	•	•	•	•
25	•	•	•	—	—	—

Schlüter®-TREP-EK

Schlüter-TREP-EK is a stainless steel stair nosing profile with a special non slip tread to create safe and attractive stair edges. It can be retrofitted to steps with tile or natural stone coverings.

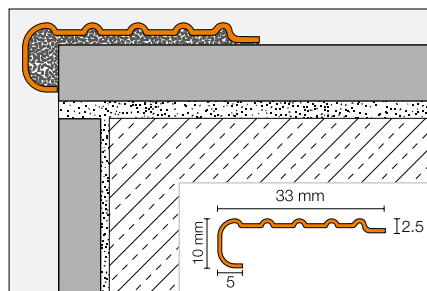

Schlüter®-TREP-EK			
stainless steel V2A			
B = mm	L = 1.00 m	L = 1.50 m	L = 2.50 m
33	•	•	•



Schlüter®-TREP-FL

Schlüter-TREP-FL is a stair nosing profile in Florentine design for enhancing the safety and visual appeal of stair edges.

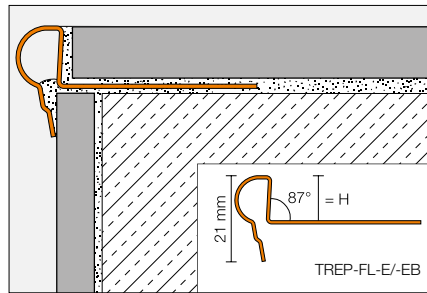

Accessories: End caps

Schlüter®-TREP-FL						
stainless steel V2A						
H = mm	Schlüter®-TREP-FL-E			Schlüter®-TREP-FL-EB brushed		
	L = 1.00 m	L = 1.50 m	L = 2.50 m	L = 1.00 m	L = 1.50 m	L = 2.50 m
9	•	•	•	•	•	•
11	•	•	•	•	•	•
12.5	•	•	•	•	•	•

Schlüter®-TREP-G / -GL

Schlüter-TREP-G / -GL is a stair nosing profile of brushed stainless steel with an adhered, non slip tread.

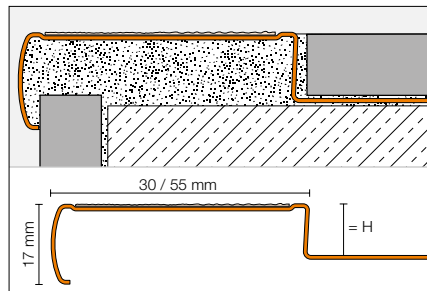

Accessories: End caps, slip resistant tape

Colours: graphite black (GS), transparent (T)



Schlüter®-TREP-G						
stainless steel V2A brushed						
H = mm	Schlüter®-TREP-G-B wide (55 mm), R11			Schlüter®-TREP-G-S narrow (30 mm), R11		
	L = 1.00 m	L = 1.50 m	L = 2.50 m	L = 1.00 m	L = 1.50 m	L = 2.50 m
9	•	•	•	•	•	•
11	•	•	•	•	•	•
13	•	•	•	•	•	•
15	•	•	•	•	•	•

Schlüter®-TREP-GL						
stainless steel V2A brushed						
H = mm	Schlüter®-TREP-GL-B wide (55 mm), R10			Schlüter®-TREP-GL-S narrow (30 mm), R10		
	L = 1.00 m	L = 1.50 m	L = 2.50 m	L = 1.00 m	L = 1.50 m	L = 2.50 m
9	•	•	•	•	•	•
11	•	•	•	•	•	•
13	•	•	•	•	•	•
15	•	•	•	•	•	•



Schlüter®-TREP-GK / -GLK

Schlüter-TREP-GK/-GLK is a stair nosing profile of brushed stainless steel with an adhered, non slip tread. It can be retrofitted to steps with tile or natural stone coverings.

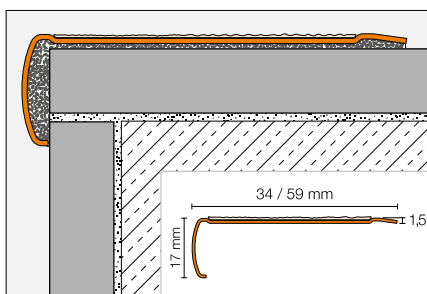

Schlüter®-TREP-GK / -GLK				
stainless steel V2A brushed				
L = m	Schlüter®-TREP-GK-B wide (59 mm), R11	Schlüter®-TREP-GK-S narrow (34 mm), R11	Schlüter®-TREP-GLK-B wide (59 mm), R10	Schlüter®-TREP-GLK-S narrow (34 mm), R10
1.00	•	•	•	•
1.50	•	•	•	•
2.50	•	•	•	•

Accessories: Slip resistant tape

Colours: graphite black (GS), transparent (T)



Schlüter®-TREP-EFK

Schlüter-TREP-EFK is a stainless steel stair-profile with a special non-slip tread to create safe and attractive stair treads. It can be adhered with installation adhesive in the corresponding milled grooves or retrofitted on stair steps.

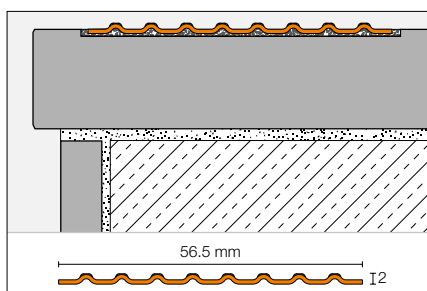

Schlüter®-TREP-EFK	
stainless steel V4A	
B = mm	L = 2.50 m
56.5	•



Movement joint and stress relieving profiles

The profiles of the Schlüter-DILEX range offer maintenance free and functional solutions for all relevant movement in tile coverings. The product range includes profile types for structural joints, perimeter joints, edge joints and connection joints. The profiles are installed at the same time as the tiles. DILEX profiles are available in various materials, depending on the expected mechanical or chemical stresses of the covering.



Schlüter®-DILEX-EMP

Schlüter-DILEX-EMP is a movement profile of stainless steel with a tongue and groove mechanism that absorbs horizontal movement.

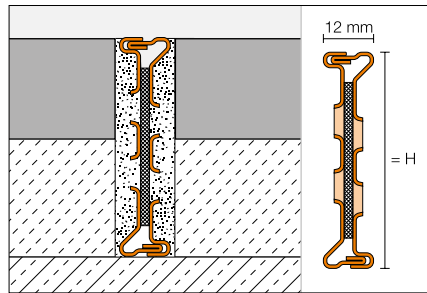

Schlüter®-DILEX-EMP	
stainless steel V2A	
H = mm	L = 2.50 m
35	•
50	•
65	•

Schlüter®-DILEX-KSBT

Schlüter-DILEX-KSBT is a structural movement profile with edge protection. The profile's anchoring legs, made of stainless steel, are connected to a 20 mm or 30 mm wide movement zone made of soft synthetic rubber.

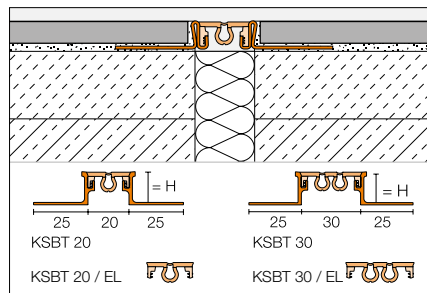

Colours: cream (C), dark anthracite (DA), joint grey (FG), grey (G), graphite black (GS), light beige (HB), stone grey (SG)



Accessories: Movement zone inserts, cross joint insert, stainless steel insert for movement zone for EKSBT 30

Schlüter®-DILEX-EKSBT				
Edelstahl V2A/V4A				
H = mm	Schlüter®-DILEX-EKSBT 20 L = 2.50 m	Schlüter®-DILEX-EKSBT 30 L = 2.50 m	Schlüter®-DILEX-EKSBT 20 V4A L = 2.50 m	Schlüter®-DILEX-EKSBT 30 V4A L = 2.50 m
8	•	•	•	•
10	•	•	•	•
11	•	•	•	•
12.5	•	•	•	•
14	•	•	•	•
16	•	•	•	•
18.5	•	•	—	—
21	•	•	—	—
25	•	•	—	—
30	•	•	—	—

Schlüter®-DILEX-EDP

Schlüter-DILEX-EDP is a movement profile of stainless steel with a tongue and groove mechanism that absorbs horizontal movement.

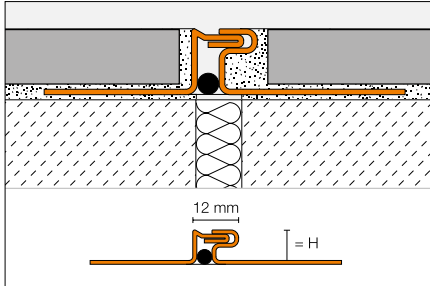

Schlüter®-DILEX-EDP	
stainless steel V2A	
H = mm	L = 2.50 m
8	•
9	•
10	•
11	•
12.5	•
14	•
16	•
18.5	•
21	•
25	•
30	•



Schlüter®-DILEX-KS

Schlüter-DILEX-KS is a movement profile with edge protection. The profiles anchoring legs are connected to a movement zone made of soft synthetic rubber.

Schlüter®-DILEX-EKSN		
stainless steel V2A/V4A		
H = mm	Schlüter®-DILEX-EKSN	Schlüter®-DILEX-EKSN V4A
	L = 2.50 m	L = 2.50 m
8	•	•
10	•	•
11	•	•
12.5	•	•
14	•	•
16	•	•
18.5	•	—
21	•	—
25	•	—
30	•	—

Farben: cream (C), dark anthracite (DA), joint grey (FG), grey (G), graphite black (GS), light beige (HB), pastel grey (PG), stone grey (SG)

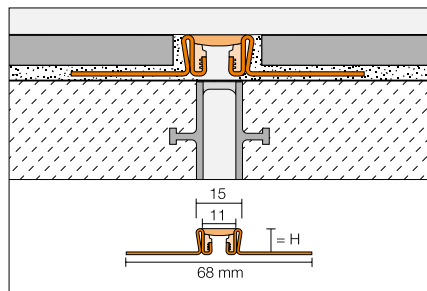

Accessories: Movement zone inserts and cross joint inserts



Schlüter®-DILEX-EKSB

Schlüter-DILEX-EKSB is a movement profile with edge protection for floor coatings and other thin floor coverings. It consists of lateral stainless steel anchoring legs that are connected to a fixed elastic insert of soft synthetic material.

Schlüter®-DILEX-EKSB		
stainless steel V2A/V4A		
H = mm	Schlüter®-DILEX-EKSB	Schlüter®-DILEX-EKSB V4A
	L = 2.50 m	L = 2.50 m
2.5	•	•
4.5	•	•
6	•	•

Colours: grey (G), graphite black (GS), light beige (HB), pastel grey (PG)

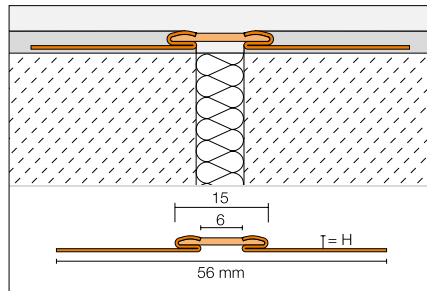

Schlüter®-DILEX-KSA

Schlüter-DILEX-KSA is a connection profile with edge protection. The profile's anchoring legs, made of stainless steel, are connected to a replaceable movement zone made of soft PVC. The profile is used for perimeter movement joints and creating transitions between coverings and fixed structures such as windows.

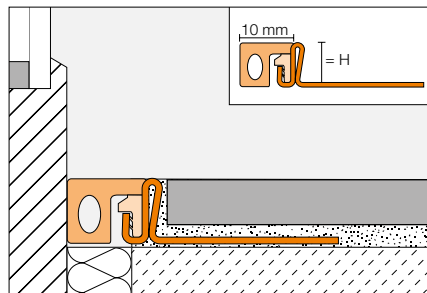

Colours: grey (G), graphite black (GS), light beige (HB), pastel grey (PG)



Schlüter®-DILEX-EKSA		
stainless steel V2A/V4A		
H = mm	Schlüter®-DILEX-EKSA	Schlüter®-DILEX-EKSA V4A
	L = 2.50 m	L = 2.50 m
8	•	•
10	•	•
11	•	•
12.5	•	•
14	•	•
16	•	•
18.5	•	—
21	•	—
25	•	—
30	•	—

Schlüter®-DILEX-HKS

Schlüter-DILEX-HKS-E is a stainless steel cove shaped profile with a maintenance free movement zone for floor to wall connections in ceramic tile coverings.

Colours: grey (G), graphite black (GS), light beige (HB), pastel grey (PG)

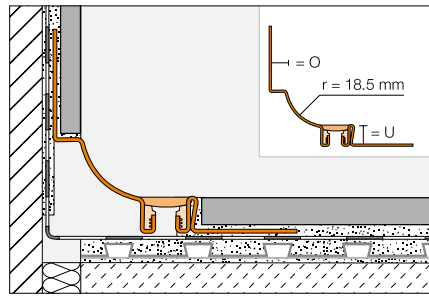

Accessories: Connectors, internal and external corners

Schlüter®-DILEX-HKS-E

stainless steel V2A/V4A

U = mm	Schlüter®-DILEX-HKS-E L = 2.50 m			Schlüter®-DILEX-HKS-E V4A L = 2.50 m		
	O = 7 mm	O = 9 mm	O = 11 mm	O = 7 mm	O = 9 mm	O = 11 mm
8	•	•	•	•	•	•
10	•	•	•	•	•	•
12.5	•	•	•	•	•	•
14	•	•	•	•	•	•
16	•	•	•	•	•	•
18	•	•	•	—	—	—
21	•	•	•	—	—	—
25	•	•	•	—	—	—
30	•	•	•	—	—	—

Schlüter®-DILEX-EHK

Schlüter-DILEX-EHK is a cove shaped profile made entirely of stainless steel for internal corners and floor to wall transitions in environments with stringent hygiene requirements.

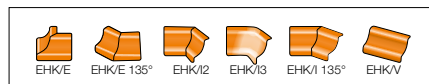
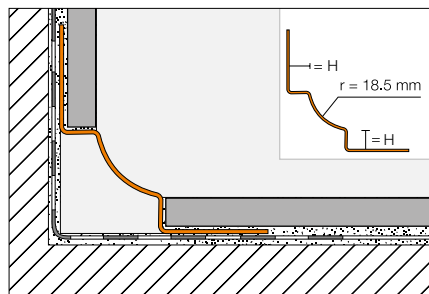

Accessories: Connectors, internal and external corners

Schlüter®-DILEX-EHK

stainless steel V2A/V4A

H = mm	Schlüter®-DILEX-EHK	Schlüter®-DILEX-EBHK brushed	Schlüter®-DILEX-EHK V4A
	L = 2.50 m	L = 2.50 m	L = 2.50 m
7	•	•	•
9	•	•	•
11	•	•	•
16	—	—	•



Schlüter®-DILEX-HKU

Schlüter-DILEX-HKU is a cove shaped profile entirely made of stainless steel for internal wall corners and floor wall transitions with stringent hygiene requirements. Due to its inner anchoring leg, the profile can be variably used for different tile thicknesses.

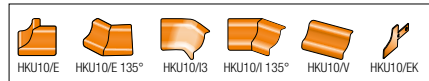
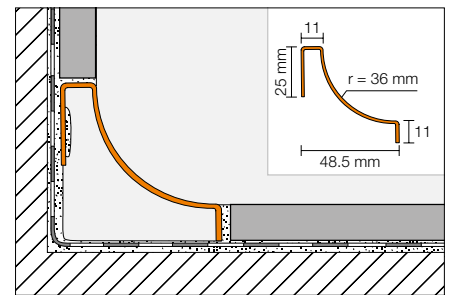
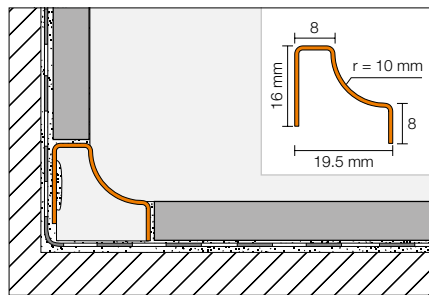

Accessories: Internal and external corners, connectors



Accessories: Internal and external corners, connectors, end caps PVC

Schlüter®-DILEX-HKU

stainless steel V2A/V4A

H = mm	Schlüter®-DILEX-HKU10-E	Schlüter®-DILEX-HKU10-EB brushed	Schlüter®-DILEX-HKU10-E V4A	Schlüter®-DILEX-HKU36-E
	L = 2.50 m	L = 2.50 m	L = 2.50 m	L = 2.50 m
8	•	•	•	—
11	—	—	—	•

Drainage

Schlüter-Systems carries a full assortment of accessories for the construction of floor-level showers with ceramic tiles and natural stone. Whether the design calls for central drainage or modern linear drainage, our Schlüter-KERDI-DRAIN and Schlüter-KERDI-LINE products provide the right solution. What's more, the tapered profiles and wall connection profiles of the Schlüter-SHOWERPROFILE family offer elegant and practical detail solutions for any design.





Schlüter®-KERDI-LINE-H

Schlüter-KERDI-LINE-H is a complete set for linear floor-level showers with a horizontal drain (DN 40 / DN 50). It can be universally used for intermediate installation in floor or wall areas.

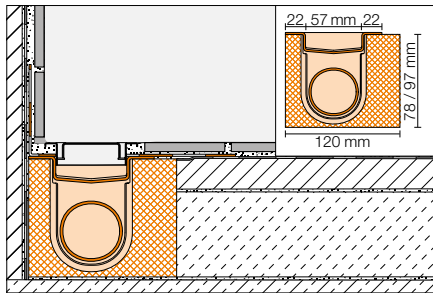

Schlüter®-KERDI-LINE-H	
stainless steel V4A linear drainage set with odour trap, horizontal DN 40 drain	
L = cm	
50	•
60	•
70	•
80	•
90	•
100	•
110	•
120	•
130	•
140	•
150	•
160	•
170	•
180	•



Schlüter®-KERDI-LINE-V

Schlüter-KERDI-LINE-V is a complete set for linear floor-level showers with a vertical drain. It can be universally used for intermediate installation in floor or wall areas.

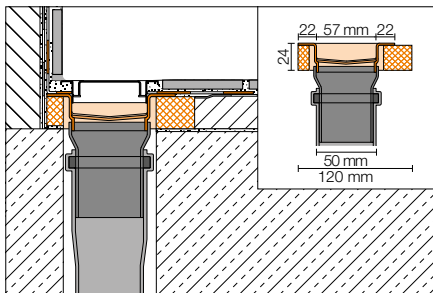

Example: KERDI-LINE-VS

Schlüter®-KERDI-LINE-V/-VS		
stainless steel V4A linear drainage set, vertical		
L = cm	Schlüter®-KERDI-LINE-V with odour trap	Schlüter®-KERDI-LINE-VS with pipe siphon
50	•	•
60	•	•
70	•	•
80	•	•
90	•	•
100	•	•
110	•	•
120	•	•
130	•	•
140	•	•
150	•	•
160	•	•
170	•	•
180	•	•



Schlüter®-SHOWERPROFILE-R

Schlüter-SHOWERPROFILE-R is a two-part wall transition profile for covering the exposed wall area where the floor slopes down to a linear drainage. The visible surface of the profile consists of brushed stainless steel. A fleece fabric is laminated to the reverse size for bonding with the tile adhesive.

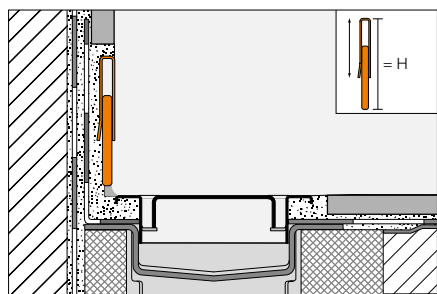

Schlüter®-SHOWERPROFILE-R		
stainless steel V4A, brushed		
H = mm	L = 1.00 m	L = 1.40 m
23-35	•	•
33-45	•	•



Schlüter®-SHOWERPROFILE-S

Schlüter-SHOWERPROFILE-S is a tapered profile made of a brush stainless steel flat profile with a 2% slope for covering the sloping edges of floor-level showers.

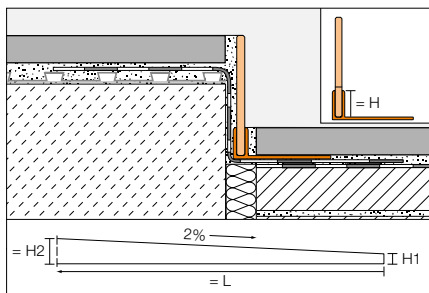

Heights: H1 = 6, 10 mm, H2 = 30–50 mm

Schlüter®-SHOWERPROFILE-S									
with rigid PVC support profile, stainless steel V4A, brushed									
H = mm	Schlüter®-SHOWERPROFILE-SPS 50 H1 = 6 mm			Schlüter®-SHOWERPROFILE-SPS 100 H1 = 10 mm			Schlüter®-SHOWERPROFILE-SPS 125 H1 = 10 mm		
	L = 2.00 m	L = 1.60 m	L = 1.20 m	L = 2.00 m	L = 1.60 m	L = 1.20 m	L = 2.00 m	L = 1.60 m	L = 1.20 m
5	•	•	•	—	—	—	—	—	—
10	—	—	—	•	•	•	—	—	—
12.5	—	—	—	—	—	—	•	•	•

Schlüter®-KERDI-LINE-A / -B / -C

Schlüter-KERDI-LINE (KLA, KLB, KLC) are insertion frames of brushed stainless steel with design grates that match the KERDI-LINE channel bodies and are also available with custom engraving (My Schlüter-KERDI-LINE).

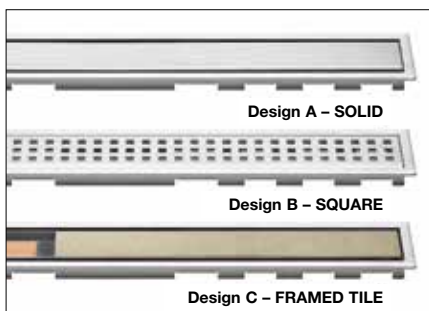

Schlüter®-KERDI-LINE-STYLE

Schlüter-KERDI-LINE-STYLE are contour frames with elegant design covers made of brushed stainless steel. The slim contour frame is seamlessly height-adjustable to accommodate covering materials in thicknesses from 6 to 18 mm.

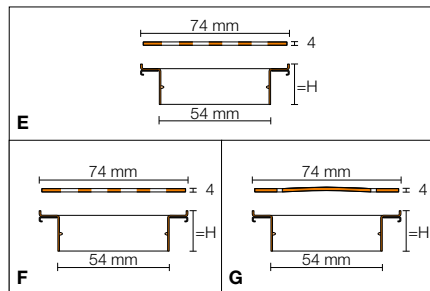
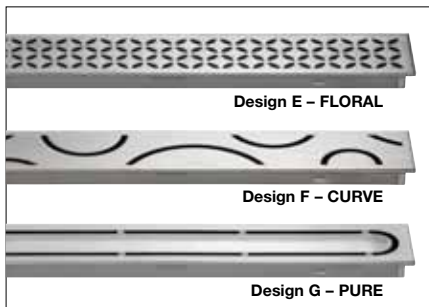
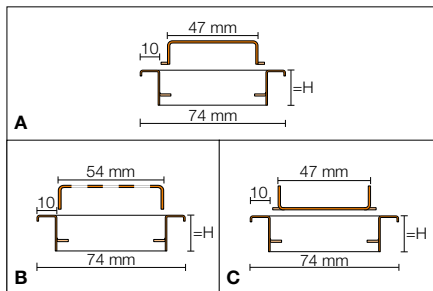

Schlüter®-KERDI-LINE									
stainless steel V4A									
L = cm	SOLID	SOLID high-gloss	SQUARE	SQUARE high-gloss	FRAMED TILE	FRAMED TILE high-gloss	FLORAL	CURVE	PURE
50	•	•	•	•	•	•	•	•	•
60	•	•	•	•	•	•	•	•	•
70	•	•	•	•	•	•	•	•	•
80	•	•	•	•	•	•	•	•	•
90	•	•	•	•	•	•	•	•	•
100	•	•	•	•	•	•	•	•	•
110	•	•	•	•	•	•	•	•	•
120	•	•	•	•	•	•	•	•	•
130	•	—	•	—	•	—	—	—	—
140	•	—	•	—	•	—	—	—	—
150	•	—	•	—	•	—	—	—	—
160	•	—	•	—	•	—	—	—	—
170	•	—	•	—	•	—	—	—	—
180	•	—	•	—	•	—	—	—	—





Schlüter®-KERDI-DRAIN

Schlüter-KERDI-DRAIN grates are design grates made of solid stainless steel to replace existing installations in tile coverings.

Schlüter®-KERDI-DRAIN design grate 1				
stainless steel V2A/V4A				
L x B = mm	V2A high-gloss with screws	V2A with screws	V4A with screws	V2A without screws
100 x 100	•	•	•	•

Schlüter®-KERDI-DRAIN Design 2 – TRAPEZOID / 3 Design – SQUARE		
stainless steel V2A brushed		
L x B = mm	Design 2	Design 3
100 x 100	•	•



Design 1 – CLASSIC
KD GR 10 ...



Design 2 – TRAPEZOID
KD GR 10 E D2

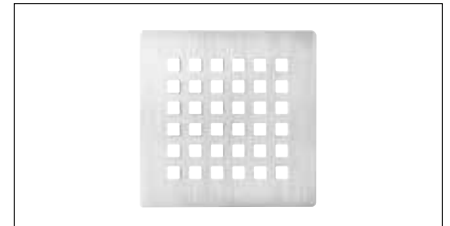

Design 3 – SQUARE
KD GR 10 E D3



Design 1 – CLASSIC ROUND
KD GR 15 E D1 ...

Schlüter®-KERDI-DRAIN Design 1 – CLASSIC / CLASSIC ROUND		
stainless steel V2A		
size = mm	round	square
150 x 150	—	•
Ø 150	•	—



Example: Design 3 with height adjustment ring
KD R10 ED3



Example: Floor drain KD BV 100 with design 2
2 KD R10 ED2



Schlüter®-KERDI-DRAIN-STYLE

Schlüter-KERDI-DRAIN-STYLE grates are designer grates made of brushed solid stainless steel, designed to fit existing installations with a contour frame.

Schlüter®-KERDI-DRAIN-STYLE			
stainless steel V2A brushed			
L x B = mm	Design 5 FLORAL	Design 6 CURVE	Design 7 PURE
100 x 100	•	•	•

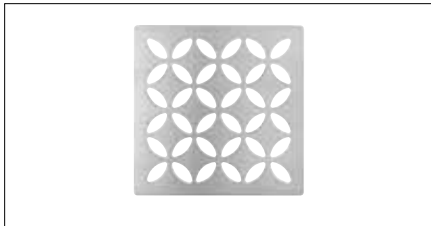

Design 5 – FLORAL
KD GIF 10 EB D5



Design 6 – CURVE
KD GIF 10 EB D6



Design 7 – PURE
KD GIF 10 EB D7



Example: design 6 – CURVE
with height adjustment ring KD IF10 EB D6



Example: Floor drain KD BH 40
with design 7 KD GIF 10 EB D7



Schlüter®-SHELF-E-S1

Schlüter-SHELF-E are triangular shelves for installation in corners. They are available in the design variants FLORAL, CURVE, PURE, SQUARE and WAVE in the material brushed stainless steel. The shelves can be integrated into the tile assembly during tile installation or retrofitted into the joints of tiled walls, using the 2 mm attachment tabs.

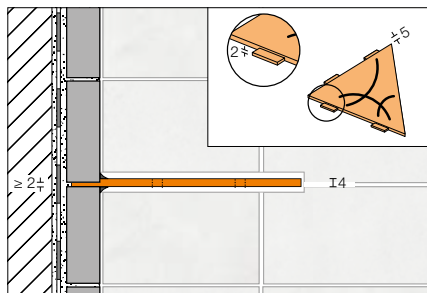

Schlüter®-SHELF-E-S1

Shelve, brushed stainless steel V2A

Farbe	PURE	SQUARE	WAVE	FLORAL	CURVE
EB	•	•	•	•	•

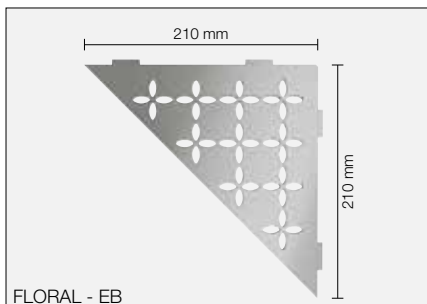
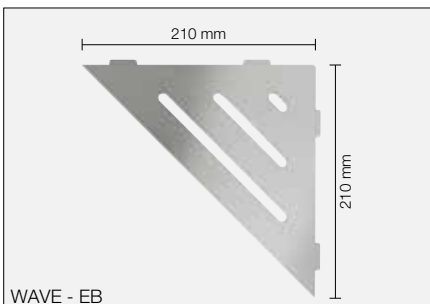
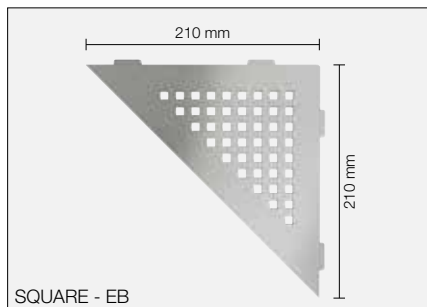
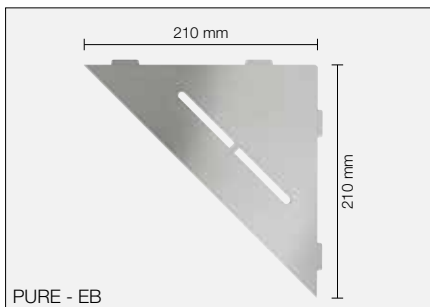



Schlüter®-SHELF-E-S2

Schlüter-SHELF-E are pentagonal shelves for installation in corners. They are available in the design variants FLORAL, CURVE, PURE, SQUARE and WAVE in the material brushed stainless steel. The shelves can be integrated into the tile assembly during tile installation or retrofitted into the joints of tiled walls, using the 2 mm attachment tabs.

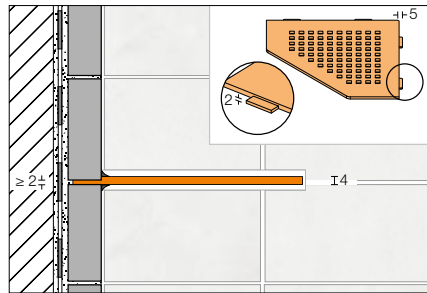

Shelve, brushed stainless steel V2A					
Ablage, Edelstahl V2A gebürstet					
Farbe	PURE	SQUARE	WAVE	FLORAL	CURVE
EB	•	•	•	•	•

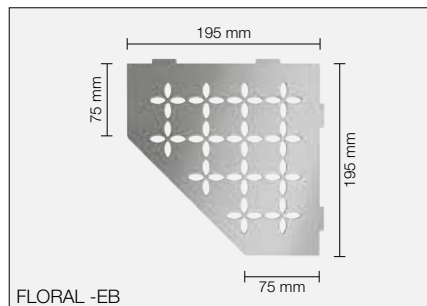
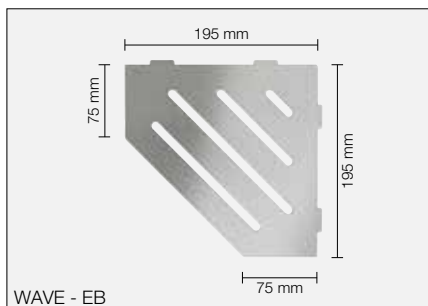
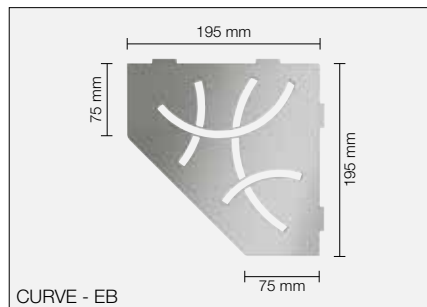
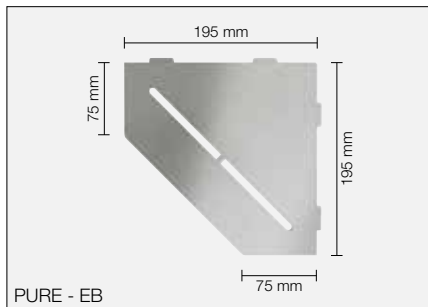



Schlüter®-SHELF-E-S3

Schlüter-SHELF-E-S3 are quadrangular shelves with asymmetrical side lengths for installation in corners. They are available in the design variants FLORAL, CURVE, PURE, SQUARE and WAVE in the material brushed stainless steel. The shelves can be integrated into the tile assembly during tile installation or retrofitted into the joints of tiled walls, using the 2 mm attachment tabs.

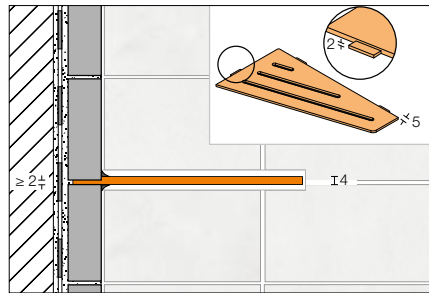

Schlüter®-SHELF-E-S3					
Shelve, brushed stainless steel V2A					
Farbe	PURE	SQUARE	WAVE	FLORAL	CURVE
EB	•	•	•	•	•

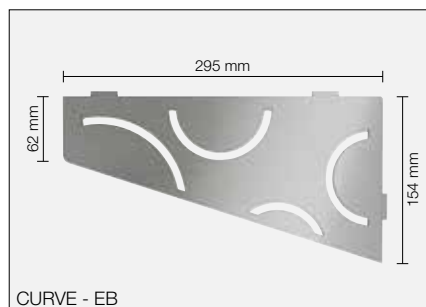
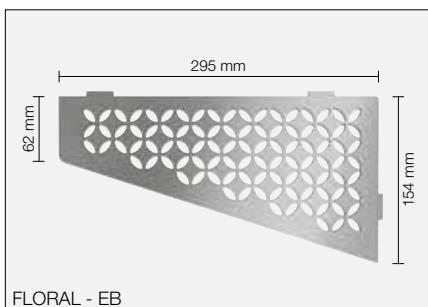
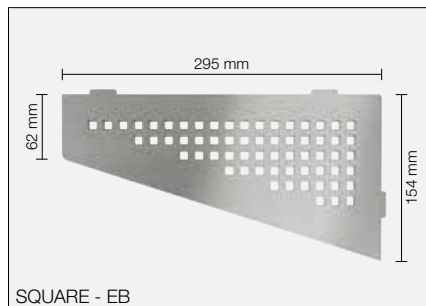



Schlüter®-SHELF-N

Schlüter-SHELF-N are rectangular shelves for use in prefabricated Schlüter-KERDI-BOARD-N niches. They are available in the design variants FLORAL, CURVE, PURE, SQUARE and WAVE in the material brushed stainless steel. They are precisely fitted as a shelf in KERDI-BOARD-N niches during tile installation.

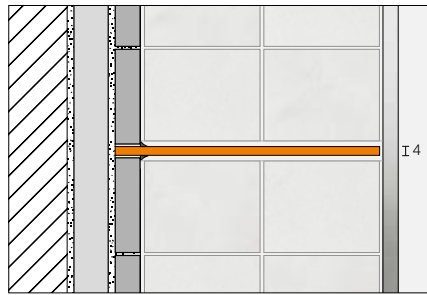

SQUARE - EB

Schlüter®-SHELF-N					
Shelve, brushed stainless steel V2A					
Farbe	PURE	SQUARE	WAVE	FLORAL	CURVE
EB	•	•	•	•	•

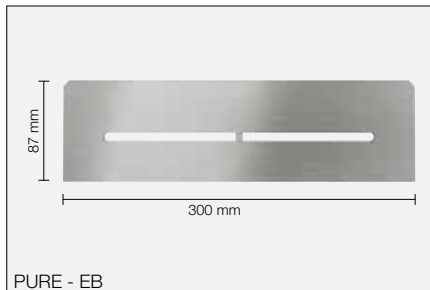

PURE - EB

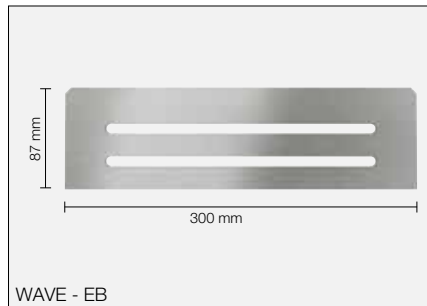

WAVE - EB

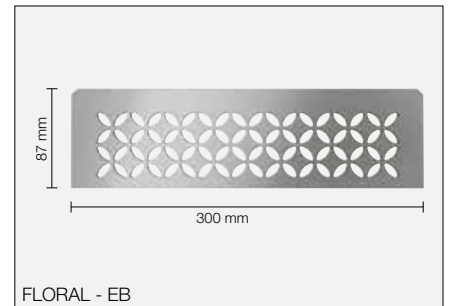

FLORAL - EB

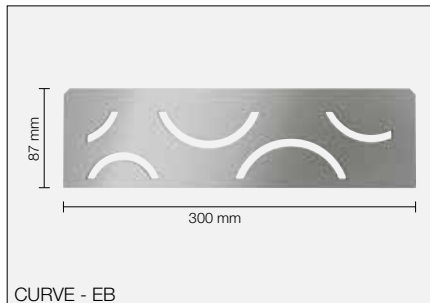

CURVE - EB



Schlüter®-SHELF-W

Schlüter-SHELF-W are rectangular shelves for installation in wall surfaces. They are available in the design variants FLORAL, CURVE, PURE, SQUARE and WAVE in the material brushed stainless steel. The trapezoid perforated anchoring legs are integrated into the tile assembly during tile installation.

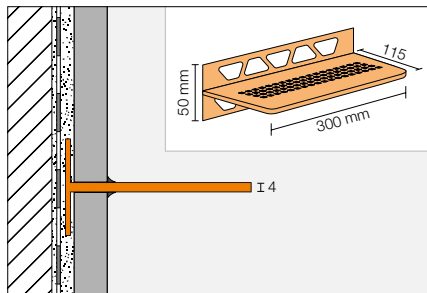

Schlüter®-SHELF-W-S3

Shelve, brushed stainless steel V2A

Farbe	PURE	SQUARE	WAVE	FLORAL	CURVE
EB	•	•	•	•	•

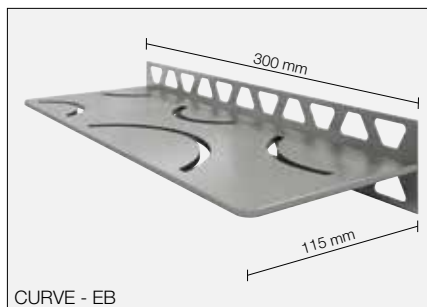
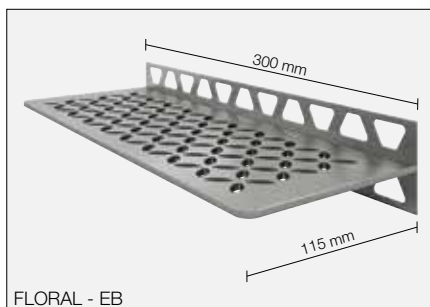
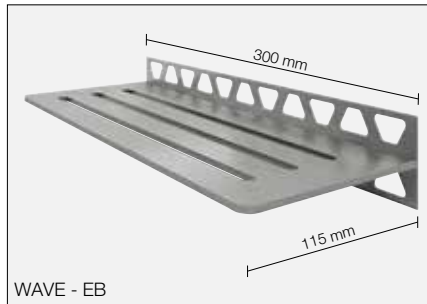
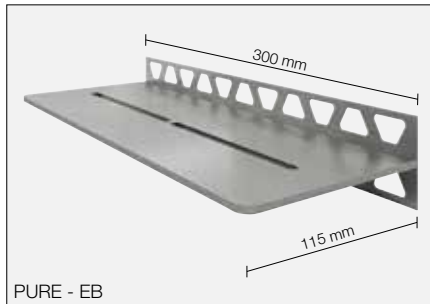



Balcony and terrace assemblies

Schlüter-Systems provides a complete product range of matching components for balcony and terrace constructions with ceramic tile and natural stone. The system offers a broad spectrum of solutions for every individual project and includes stainless steel Schlüter-BARA profiles for balconies, as well as Schlüter-TROBA-LINE height adjustable drainage channels for installation with a low transition height to door elements.





Schlüter®-BARA-ESOT

Schlüter-BARA-ESOT is a skirting support profile made of stainless steel for use in applications where no load bearing substrate is available to support the skirting tiles.

Schlüter®-BARA-ESOT	
stainless steel V2A	
H = mm	L = 2.50 m
60	•
110	•

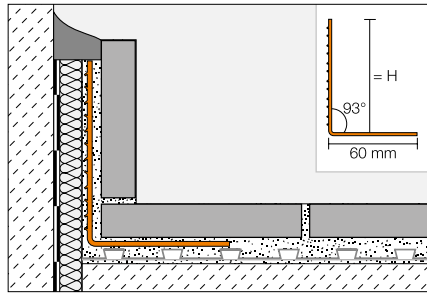

Schlüter®-TROBA-LINE-TL

Schlüter-TROBA-LINE-TL is a stainless steel drainage channel, which can be installed with low transition heights to door elements on balconies and terraces to prevent the accumulation of water. It can also be used as an area drainage channel.

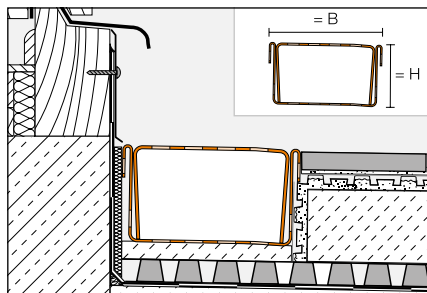

Schlüter®-TROBA-LINE-TL												
stainless steel V2A, perforated gutter												
H = mm	B = 75 mm				B = 110 mm				B = 160 mm			
	L = 2.00 m	L = 1.50 m	L = 1.00 m	L = 0.75 m	L = 2.00 m	L = 1.50 m	L = 1.00 m	L = 0.75 m	L = 2.00 m	L = 1.50 m	L = 1.00 m	L = 0.75 m
20	•	•	•	•	•	•	•	•	•	•	•	•
40	•	•	•	•	•	•	•	•	•	•	•	•

Schlüter®-TROBA-LINE-TLG												
stainless steel V2A, closed gutter												
H = mm	B = 75 mm				B = 110 mm				B = 160 mm			
	L = 2.00 m	L = 1.50 m	L = 1.00 m	L = 0.75 m	L = 2.00 m	L = 1.50 m	L = 1.00 m	L = 0.75 m	L = 2.00 m	L = 1.50 m	L = 1.00 m	L = 0.75 m
20	•	•	•	•	•	•	•	•	•	•	•	•
40	•	•	•	•	•	•	•	•	•	•	•	•

Schlüter®-TROBA-LINE-TL/H

Schlüter-TROBA-LINE-TL/H is a height adjustment for the stainless steel drainage channel TROBA-LINE-TL.

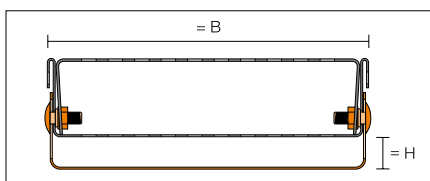

Schlüter®-TROBA-LINE-TL/H			
height adjustment insert, stainless steel V2A			
H = mm	B = 75 mm	B = 110 mm	B = 160 mm
	L = 135 mm	L = 135 mm	L = 135 mm
0-20	•	•	•
20-40	•	•	•

Schlüter®-TROBA-LINE-TL/V

Schlüter-TROBA-LINE-TL/V is a reinforcement for Schlüter-TROBA-LINE-TL and Schlüter-TROBA-LINE-TLG to accommodate larger traffic volumes, e.g. pedestrians or wheelchair users for the widths 110 mm and 160 mm.

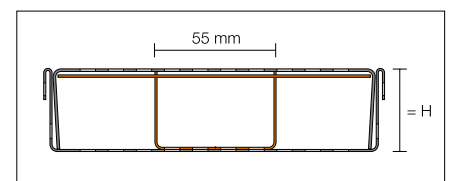



Schlüter®-TROBA-LINE-TLR-E

Schlüter-TROBA-LINE-TLR-E is a drainage channel with an upper drainage screen made of polished stainless steel which can be installed in balconies and terraces with a low transition height to door elements to prevent the accumulation of water. It can also be used as an area drainage channel for higher traffic loads.

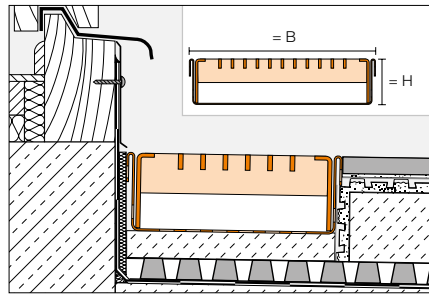

Schlüter®-TROBA-LINE-TLR-E / -TLGR-E

channel with grate, stainless steel V2A

H = mm	Schlüter®-TROBA-LINE-TLR-E perforated channel, B = 110				Schlüter®-TROBA-LINE-TLR-E perforated channel, B = 160				Schlüter®-TROBA-LINE-TLGR-E closed channel, B = 110				Schlüter®-TROBA-LINE-TLGR-E closed channel, B = 160			
	L = 2.00 m	L = 1.50 m	L = 1.00 m	L = 0.75 m	L = 2.00 m	L = 1.50 m	L = 1.00 m	L = 0.75 m	L = 2.00 m	L = 1.50 m	L = 1.00 m	L = 0.75 m	L = 2.00 m	L = 1.50 m	L = 1.00 m	L = 0.75 m
20	•	•	•	•	•	•	•	•	—	—	—	—	—	—	—	—
40	•	•	•	•	•	•	•	•	•	•	•	•	•	•	•	•

Schlüter®-TROBA-LINE-TLK-E

Schlüter-TROBA-LINE-TLK-E is a stainless steel gravel containment profile to be used at the edge of coverings or load distribution layers.

Schlüter®-TROBA-LINE-TLK-E	
stainless steel V2A	
L = cm	
75	•
100	•

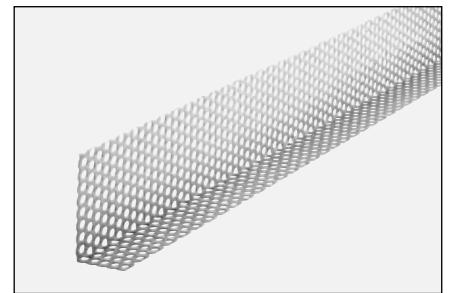
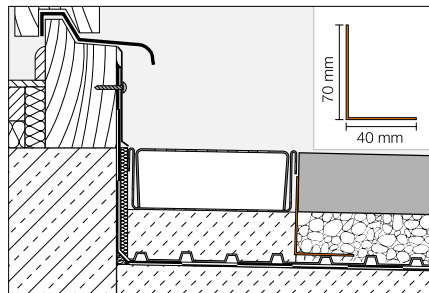

Schlüter®-KERDI-DRAIN-SP-E

Schlüter-KERDI-DRAIN-SP-E is a stainless steel spout for draining balconies and terraces that are enclosed by a parapet.

Schlüter®-KERDI-DRAIN-SP-E	
stainless steel V2A, pipe diameter 45 mm	
L = cm	
25	•
40	•

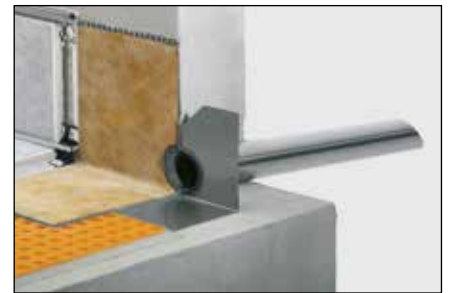
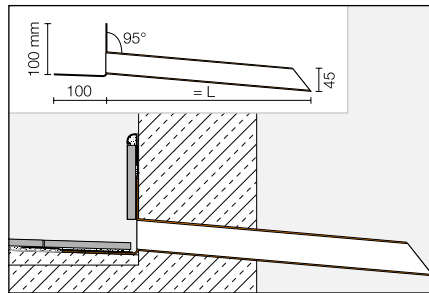

Schlüter®-BARA-RW

Schlüter-BARA-RW is an angled finishing profile of stainless steel for covering exposed edges of balconies and terraces.



Schlüter®-BARA-RW-E	
angled finishing profile, stainless steel V2A	
H = mm	L = 2.50 m
15	•
25	•
30	•
40	•
55	•
75	•
95	•
120	•
150	•

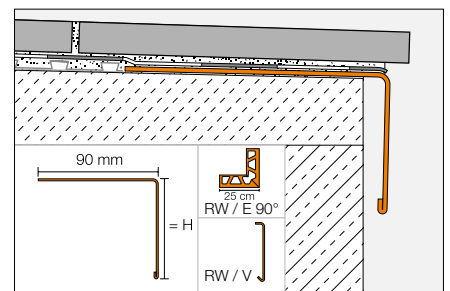

Accessories: Corners and connectors



Cost effective underfloor heating



Schlüter-BEKOTEC-THERM –
The ceramic thermal comfort floor

If you don't just want a beautifully tiled room, but a well heated one, too, we can recommend Schlüter-BEKOTEC-THERM. This ceramic thermal comfort floor combines environmentally sound heating comfort with hygiene and easy care. The patented floor assembly, with low construction height and innovative heating and control technology, turns the floor into an energy efficient and cost effective, quick reacting heating system with especially low supply temperatures. But that is not all: the ceramic thermal comfort floor is also quick and easy to install, with many system accessories.

Important for renovation projects: Our control valves allow for integrating the ceramic thermal comfort floor into existing conventional heating circuits.



Ask for a copy of our ceramic thermal comfort floor brochure today.



KERDI makes it happen

No matter what the design of your dream bathroom may be, the necessary bonded waterproofing assembly is quickly and safely created with Schlüter-KERDI. Thanks to the endless variety of ceramic tile and natural stone there are no limits to your imagination in the design.



Ask for a copy of our Schlüter-KERDI brochure today.



Informative. For those who want to know more!

Did we get you interested in products of Schlüter-Systems?
Would you like to find out more? The fastest way to find out more is online.
Visit our website www.schluter.co.uk, which offers additional details at the click of a mouse.



P R O F I L E O F I N N O V A T I O N

Schlüter-Systems KG · Schmölestraße 7 · D-58640 Iserlohn

Tel.: +49 2371 971-261 · Fax: +49 2371 971-112 · info@schlueter.de · www.schlueter-systems.com

Schlüter-Systems Ltd · Units 3-5 Bardon 22 Industrial Estate · Beveridge Lane · Coalville · Leicestershire · LE67 1TE

Tel.: +44 1530 813396 · Fax: +44 1530 813376 · sales@schluter.co.uk · www.schluter.co.uk