

# Schlüter®-KERDI-LINE-G3

Installation instructions for a suspended timber floor with a Schlüter-KERDI-SHOWER -KSLT13652000S preformed shower tray

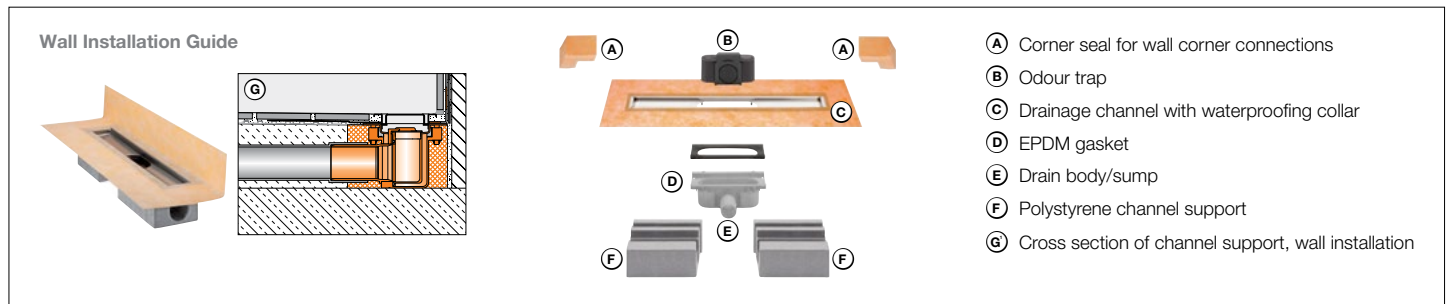

Before commencing it is important to confirm that the timber floor/substrate has been installed to BS 5385 - part 3 and is suitable for tiling. P5 grade/ green chipboard is not suitable and should be replaced with external grade plywood of, we suggest, 18mm thickness. As well as being clean, dry and free from debris the timber floor must be flat, level and load bearing.

We recommend use of the G3 Installation Accessory 'KLF43G3TA' supplied by Schlüter-Systems Ltd.

If you are using the G3 Installation Accessory 'KLF43G3TA', when you reach step 9 of these instructions please also refer to the instructions supplied with the G3 Installation Accessory 'KLF43G3TA' rather than constructing the strengthened sub-floor referred to in Step 9 and as described on page 4.

If the G3 Installation Accessory 'KLF43G3TA' is used there is no restriction on tile size or thickness, and mosaics can be used.

Tiles smaller than 300mm x 300mm or with a thickness less than 8mm should not be used unless the sub-floor is constructed and strengthened using the pre-built G3 Installation Accessory 'KLF43G3TA'.

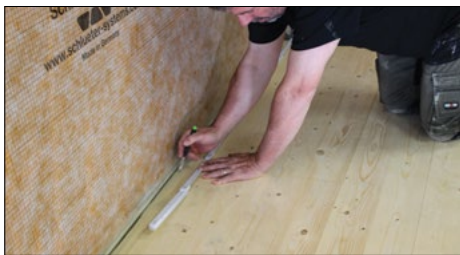

**1** Identify and mark on the floor the position of the floor joists. The position of the screws or nails in the floor should provide an indication.

Think carefully how the position of the floor joists may influence the position of the drain.



**2** Mark on the floor the outline of the Schlüter preformed shower tray to be fitted. This may be influenced by the position of the floor joists and by your use of an uncoupling membrane or underfloor heating in the surrounding floor area. For example, with an 18mm thick timber floor, a Schlüter preformed shower tray cut to 1000mm long creates a flush level access shower area when Schlüter-DITRA-HEAT-DUO is installed in the surrounding area.



**3** Carefully cut out the floor where marked, taking care to avoid any pipework or cables which may be in the floor void.



**4** Determine the position of the linear drain in the floor, taking into consideration the position of the floor joists and the size of the shower tray. The drain could be positioned either centrally or offset between the joists, but is usually positioned central to the shower tray width.



**5** Check the width and length of the Schlüter preformed shower tray to be fitted and using a utility knife, cut to size.



**6** Using exterior grade 18mm plywood, construct the sub-floor where the shower tray and drain will be installed, fixing supporting battens to the floor joists at a depth so the sub-floor will sit flush with the top of the joists.

Installation video





**7** Screw fix the sub-floor to the battens, ensuring it is level. At this stage do not fix battens or the sub-floor to the area where the drain body/sump will be installed.

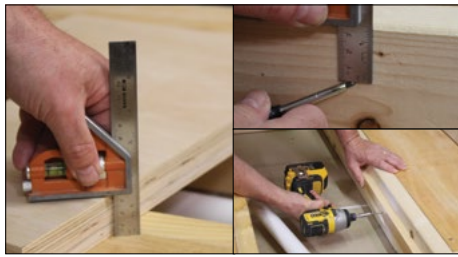

**8** Fix supporting battens to the side of the joists in the section of the floor where the drain will be fitted. The top of the battens should be positioned 36mm from the top of the joists. Use screws sized to penetrate the joists by at least 10mm.



**9** Either construct and strengthen the sub-floor in the section of the floor where the drain will be fitted or cut the pre-built G3 Installation Accessory 'KLF43G3TA' to size. For guidance on constructing and strengthening the sub-floor see page 4. For guidance on using the pre-built G3 Installation Accessory 'KLF43G3TA' see steps 10 to 13. We recommend using the pre-built G3 Installation Accessory 'KLF43G3TA'.



**10** Take the longer piece of plywood from the box containing the G3 Installation Accessory 'KLF43G3TA' and cut to size, so it fits securely between the joists ensuring the opening is where the drain will be positioned. If joist positions necessitate fitting the drain away from the wall, ensure it still fits within the level end of the tray. The drain could be positioned either centrally or offset between the joists, but is usually positioned central to the shower tray width. It may be necessary to shorten the pieces of plywood by cutting them behind the cut-out area/where they position up to the wall.

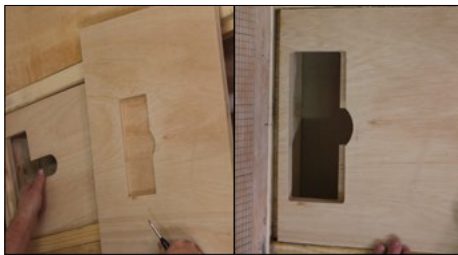

**11** Take the shorter piece of plywood from the box containing the G3 Installation Accessory 'KLF43G3TA' and position it over the piece of plywood cut-to-size in step 10. The rectangular openings should be aligned and the shorter piece of plywood cut to size so it fits on top of the longer piece and between the joists.



**12** Using screws, secure the longer piece of plywood to the battens described in step 8.



**13** Position the shorter piece of plywood over the longer piece secured to the battens in step 12, ensuring the routed-out section is face down and the cut-outs align. Glue the two pieces of plywood together (using a PVA-based D3 waterproof wood glue such as Gorilla Wood Glue) and then screw together. Use screws sized to penetrate the second piece of plywood by at least 10mm. Screws should be no further than 150-200mm apart across the whole of this piece of strengthened sub-floor.



**14** Cut the white polystyrene channel supports to size, ensuring they will fit tightly up to either side of the drain body/sump. Cut the adhesive tape to size and adhere to the underside of the drain. Carefully attach the polystyrene channel supports to the adhesive tape, ensuring they are firmly attached to the underside of the drain.

It is usual for the wider channel support to be fitted on the outlet side of the drain and the thinner channel support fitted on the non-outlet side and to both ends. However, this can be varied as per the following suggestions:

Drain Position	Outlet Direction	Wall Tile	Support on Outlet Side	Support on Non-Outlet Side
Perimeter	Through Wall	≤12.5mm	17mm	38mm
Perimeter	Under Tray	≤12.5mm	38mm	17mm
Perimeter	Through Wall	>12.5mm	38mm	17mm
Perimeter	Under Tray	>12.5mm	17mm	38mm



**15** Place the drain into position, with the drain body/sump sitting within the cut-out in the piece of sub-floor created as described on page 4 or within the cut-out in the G3 Installation Accessory 'KLF43G3TA'.



**16** Cut two further pieces of 18mm exterior grade plywood to fit, one on top of the other, in the remaining part of the sub-floor. Check they fit and then remove.



**17** If strengthening the sub-floor as described on page 4 (and not using the pre-built G3 Installation Accessory 'KLF43G3TA') screw fix it into the supporting battens described in step 8, ensuring it finishes flush with the top of the joists. Otherwise proceed directly to step 18.



**18** Remove the drain and using solvent weld adhesive glue bends, as appropriate, to the outlet of the drain. One Floplast WS19 135° (45°) bend and one Floplast WS77 135° (45°) conversion bend usually works well.



**19** Apply a thin bed of C2 classification tile adhesive to the area of the sub-floor where the drain will be installed and set the channel support in place, ensuring it is level along its length and across its width.



**20** Connect the drain outlet to the building drainage system ensuring an appropriate fall on the waste pipe. Check for leaks. Using a spirit level, check the drain is still level along its length and across its width, adjusting if necessary.



**21** Place the remaining part of the sub-floor into position, screw fixing the shorter of the two pieces of plywood cut in step 16 to the battens. The longer piece should be placed on top of the lower piece and on top of the 'ledge' described in step C on page 4, or as part of the G3 Installation Accessory 'KLF43G3TA'. The top piece should then be screwed to the bottom piece.



**22** Using a utility knife and the pre-printed markings on the back, measure and cut out the sloped tray Schlüter-KERDI-SHOWER KSLT13652000S to accommodate the drainage channel. If the drainage channel is fitted away from the wall ensure it still fits within the level end of the tray, and use either 12.5mm thick KERDI-BOARD, or the offcuts from the level end of the tray, to infill the gap between the wall and the tray.



**23** Using an appropriate notched tiling trowel, apply a bed of tile adhesive to the surface of the sub-floor where the shower tray will be installed. Carefully place the preformed shower tray on top of the adhesive bed, sliding the tray under the flange of the drainage channel. Ensure it is solidly bedded, adjusting the trowel size if necessary. Care should be taken to ensure the channel is not lifted.

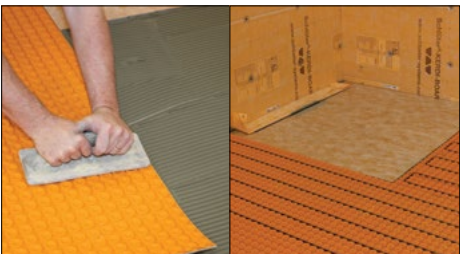

**24** If Schlüter-DITRA uncoupling membrane, or Schlüter-DITRA-HEAT-E /-DUO underfloor heating is being used, apply a bed of adhesive to the floor and adhere the membrane. As per Product Data Sheet 6.1, a 3 x 3 mm or 4 x 4 mm notched trowel should be used to install DITRA. As per Product Data Sheet 6.4, a 6 x 6 mm notched trowel should be used to install DITRA-HEAT-E/-DUO.



**25** Adhere the Schlüter-KERDI collar, using the sealing adhesive Schlüter-KERDI-COLL-L (see Product Data Sheet 8.4), to the adjoining waterproofing assembly with a 3 x 3 mm or 4 x 4 mm notched trowel and the comb provided. Completely embed the KERDI collar in this assembly, observing the curing times of all materials.



**26** Cut the supplied Schlüter-KERDI-KERECK inside corner to size and attach it with KERDI-COLL-L.



**27** If Schlüter-KERDI-BOARD is used on the wall, use KERDI-COLL-L with a piece of Schlüter-KERDI-KEBA sealing band to waterproof the penetrations.

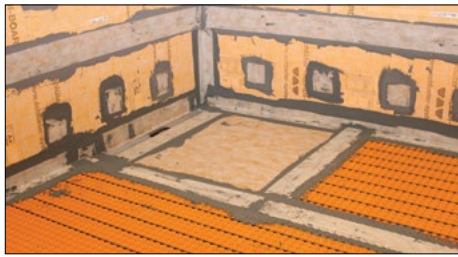

**28** Use KERDI-COLL-L to create tightly sealed wall connections with KERDI-KEBA sealing band.



**29** Insert the frame and spacer strip. If the 30mm high frame is being used (only suitable for use with a central outlet position) adjust the grate support around the trap to allow for cleaning.



**30** Use the supplied height-adjustment aid to adjust the frame to the thickness of the tile covering.



**31** Use tile adhesive to fill beneath the frame on all sides and install the tile covering.



**32** Remove the spacer strip and height-adjustment aid after curing. Insert the grate.

If not using the G3 Installation Accessory 'KLF43G3TA' described in steps 10 to 13: Constructing the strengthened sub-floor referred to in Step 9.



**A** Cut a piece of 18mm exterior grade plywood, 400mm long, so it fits securely between the joists where the drain will be positioned. Stick template to this piece of plywood so that the cut-out area is positioned where the drain will be located in the floor. If joist positions necessitate fitting the drain away from the wall ensure it will still fit within the level end of the tray. The drain could be positioned either centrally or offset between the joists, but is usually positioned central to the shower tray width.



**B** Cut the opening as per template.



**C** Position the piece of sub-floor created in steps A & B over a further piece of 18mm exterior grade plywood, approximately 500mm long, lining up the ends of the plywood pieces that will be fitted nearest to the wall. Doing this will create a 'ledge' for the part of the sub-floor referred to in steps 16 & 21 to sit on and be secured to. Use the cut-out in the top piece of plywood to draw the shape onto the bottom piece of plywood.



**D** Following the outline of the drawn shape, cut the opening into the piece of plywood.

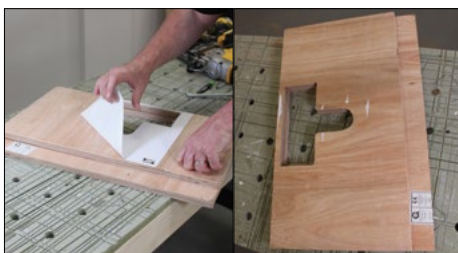

**E** Remove the template used in steps A & B. Place the two pieces of plywood on top of each other ensuring the cut-outs align and glue (using a PVA-based D3 waterproof wood glue such as Gorilla Wood Glue) and screw together. Use screws sized to penetrate the second piece of plywood by at least 10mm. Screws should be no further than 150mm apart across the whole of this piece of strengthened sub-floor. Attach to the battens described in step 8.

**Steps A to E can be avoided, and the installation simplified, if the G3 Installation Accessory 'KLF43G3TA' is used.** We recommend the G3 Installation Accessory 'KLF43G3TA' is used. If you wish to purchase it please speak with the distributor that supplied you with the drain and shower board, asking for the G3 Installation Accessory 'KLF43G3TA'.

**IMPORTANT:** Tiles smaller than 300 x 300 mm or with a thickness less than 8mm should not be used unless the sub-floor is constructed and strengthened using the pre-built G3 Installation Accessory 'KLF43G3TA' supplied by Schlüter-Systems Ltd. If the G3 Installation Accessory 'KLF43G3TA' is used there is no restriction on tile size or thickness, and mosaics could be used.

#### Constructing the strengthened sub-floor

