

Schlüter®-DESIGNBASE-SL

Wall corners and edge profiles
Decorative skirting profile

16.2
Product data sheet

Application and function

Schlüter-DESIGNBASE-SL is a high-quality profile to quickly create skirting covers.

Schlüter-DESIGNBASE-SL-A, made of colour coated or anodised aluminium, is available in heights of 60 and 80 mm.

Schlüter-DESIGNBASE-SL-E, made of brushed stainless steel (V2A), is available in heights of 110 and 160 mm.

The profile is attached to wall areas with a suitable installation adhesive (e.g. Schlüter-KERDI-FIX). Optionally, it can be fitted with a sealing lip that is available as an accessory to protect the edge joint from moisture and to reduce the transmission of impact sound. The DESIGNBASE-SL assortment also includes matching internal and external metallic corner pieces and end caps to easily create visually appealing connections.

Material

Schlüter-DESIGNBASE-SL is available in the following materials:

- AE = anodised aluminium
- AEEB = brushed stainless steel effect anodised aluminium
- AC = colour coated aluminium
- C/A = MyDesign by Schlüter-Systems
- EB = brushed stainless steel (V2A) material no. 1.4301 = AISI 304

Material properties and areas of application:

In special cases, the suitability of the profile must be verified, based on the anticipated chemical or mechanical stresses. The information provided below is intended as a general guideline.

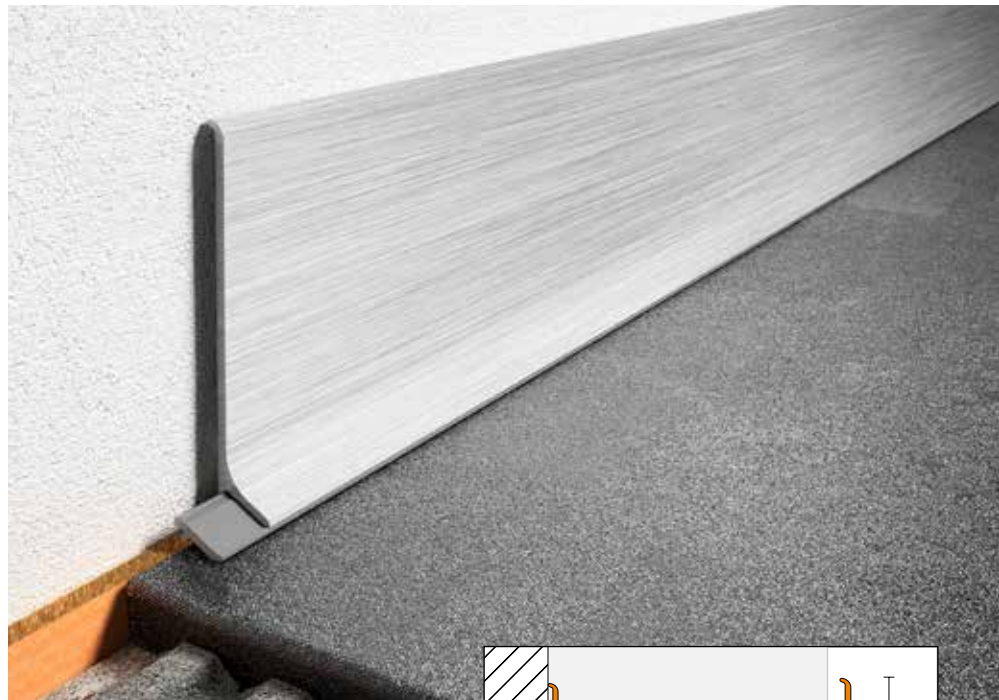

Anodised aluminium: The aluminium features an anodised finish that retains a uniform appearance during normal use. Damage to the anodised surfaces can be restored with paint. Surface areas must be protected against abrasion or scratching. Aluminium is sensitive to alkaline media. Cementitious materials, in conjunction with moisture, become alkaline, which may result in corrosion depending on the concentration and length of exposure (aluminium hydroxide formation).

For this reason, remove adhesive or grouting material immediately from all visible areas and do not cover freshly installed coverings with foil.

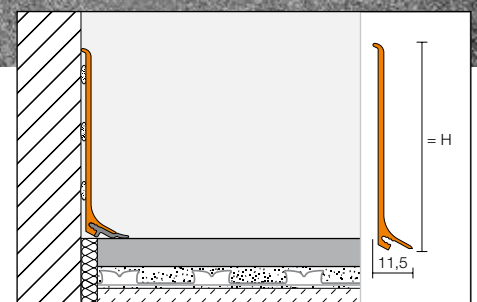

Schlüter®-DESIGNBASE-SL-A

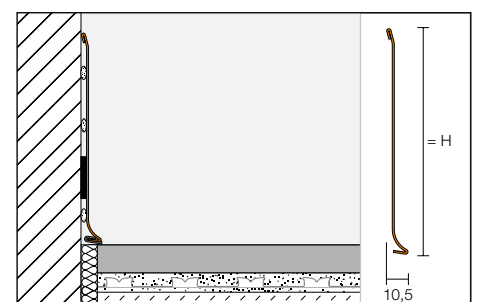

Schlüter®-DESIGNBASE-SL-E



Stainless steel: Stainless steel can withstand high mechanical stress and is highly resistant against chemicals. Even stainless steel of quality 1.4301 is not resistant to all chemical stresses. Substances such as hydrochloric or hydrofluoric acid or certain chloride and brine concentrations may cause damage. The anticipated chemical stresses should therefore be verified in advance.

DESIGNBASE-SL-AC (colour coated aluminium): The aluminium is suitably pre-treated and then powder-coated with a polyurethane covering. The coating is colour-stable, as well as UV- and weather-resistant. Visible edges should be protected against abrasion.



As part of the MyDesign by Schlüter-Systems* series, Schlüter-DESIGNBASE-SL-AC can be ordered with a coating in 190 colours of the RAL Classic chart (see -DESIGNBASE-SL-AC for further properties).

* The product advisors of our sales service and our Technical Department will be pleased to assist you with any questions you may have about MyDesign by Schlüter-Systems.

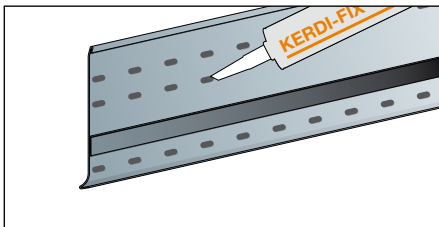

Installation of DESIGNBASE-SL-E



Schlüter®-DESIGNBASE-SL-E

Installation

1. Adhere DESIGNBASE-SL with the installation adhesive KERDI-FIX or an equivalent material. Apply a sufficient number of adhesive spots on the reverse of the profile - above and below the spacer in the case of DESIGNBASE-SL-E; see illustration - and set the profile in place. Remove any substances that may inhibit bonding, such as grease etc. prior to applying the installation adhesive.

Note: Optionally, the profile can be fitted with a sealing lip that is available as an accessory (see drawing) to protect the edge joint from moisture and to reduce the transmission of impact sound. The sealing lip is pressed firmly into the profile from the front for the aluminium variant, or clipped on from the back for the stainless steel variant, so that its front edge is flush with the profile (see drawing for correct/incorrect installation).

2. Remove any excess adhesive with a suitable cleaning product.

Note

DESIGNBASE-SL requires no special maintenance or care. Do not use abrasive cleaning agents on the sensitive surfaces. Damage to the anodised surfaces can be restored with paint. All cleaning agents must be free of hydrochloric and hydrofluoric acid. Regularly treat stainless steel surfaces with a polish such as Schlüter-CLEAN-CP to retain their shine.

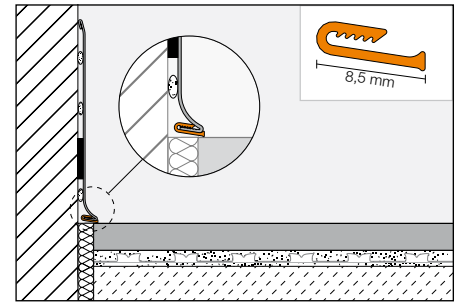

Sealing lip Schlüter®-DESIGNBASE-SLZ-E

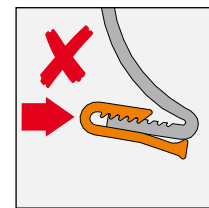

Incorrect - SLZ-E

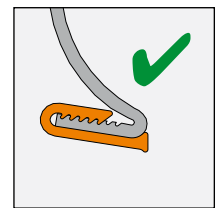

Correct - SLZ-E

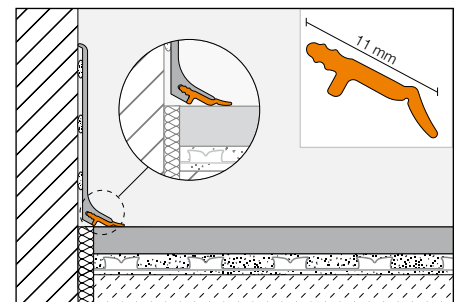

Sealing lip Schlüter®-DESIGNBASE-SLZ

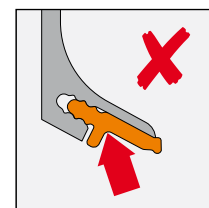

Incorrect - SLZ

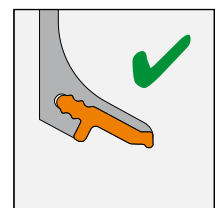

Correct - SLZ



Product overview:

Schlüter®-DESIGNBASE-SL-A

AE = anodised aluminium / AEEB = brushed stainless steel effect anodised aluminium

Supplied length: 2.50 m

H = mm	60	80
AE	•	•
AEEB	•	•
External corner	•	•
Internal corner	•	•
Connector	•	•
Sealing lip	•	•
End cap	•	•

Schlüter®-DESIGNBASE-SL-AC

AC = colour coated aluminium

Supplied length: 2.50 m

H = mm	60	80
MBW	•	•
C/A*	•	•
External corner	•	•
Internal corner	•	•
Connector	•	•
Sealing lip	•	•
End cap	•	•

Colour: MBW = matte brilliant white

* RAL colour coating

Schlüter®-DESIGNBASE-SL-E

EB = brushed stainless steel

Supplied length: 2.50 m

H = mm	110	160
External corner	•	•
Internal corner	•	•
Connector	•	•
Sealing lip	•	•
End cap	•	•

Text template for tenders:

_____linear metres of Schlüter-DESIGN-BASE-SL as a high-quality profile for quickly creating skirting coverings, to be supplied and professionally installed. The installation of pre-fabricated parts such as internal and external corners, connector or sealing lip is to be

- included in the unit prices,
- invoiced separately.

The manufacturer's specifications must be observed.

Material:

- AE = anodised aluminium
- AEEB = brushed stainless steel effect anodised aluminium
- AC = colour coated aluminium
- C/A = MyDesign by Schlüter-Systems
- EB = brushed stainless steel

Art.-No.: _____

Material: _____/m

Labour: _____/m

Total: _____ €/m

